

Save These Instructions!

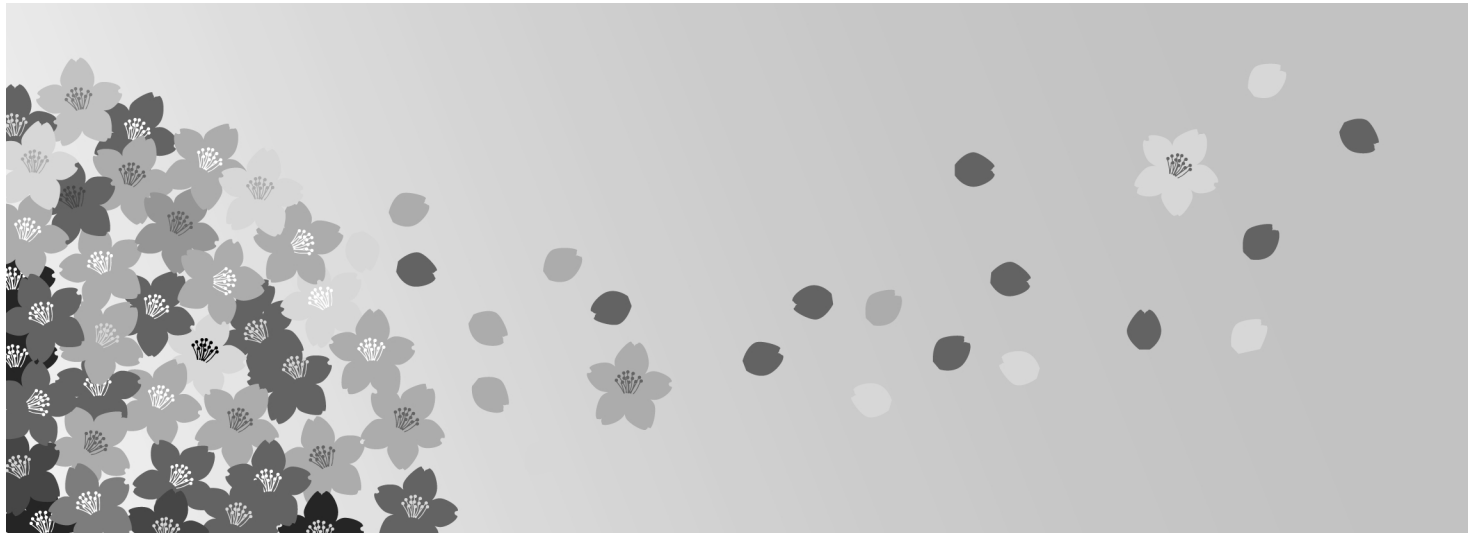

- 1. RCS-SH80UG** (Wired type: for all indoor units)
- 2. RCS-SH80UA.WL** (Wireless type: for X and T type indoor units)
- RCS-BH80UA.WL** (Wireless type: for K and U type indoor units)
- 3. TM-SH80UG** (Weekly Timer)
- 4. SHA-KC64UG** (System Remote Controller)

- 1**
- 2**
- 3**
- 4**

Indoor Units

SEMI-CONCEALED	CEILING-MOUNTED	WALL-MOUNTED	CONCEALED DUCT
(4-WAY)			
XH1242		KH1242	UH1242
XH1842		KH1842	UH1842
XH2442	TH2442	KH2442	UH2442
XH3642	TH3642	KH3632	UH3642
XH4242	TH4242		

Split System Air Conditioner

• **INSTRUCTION MANUAL**

Save These Instructions!

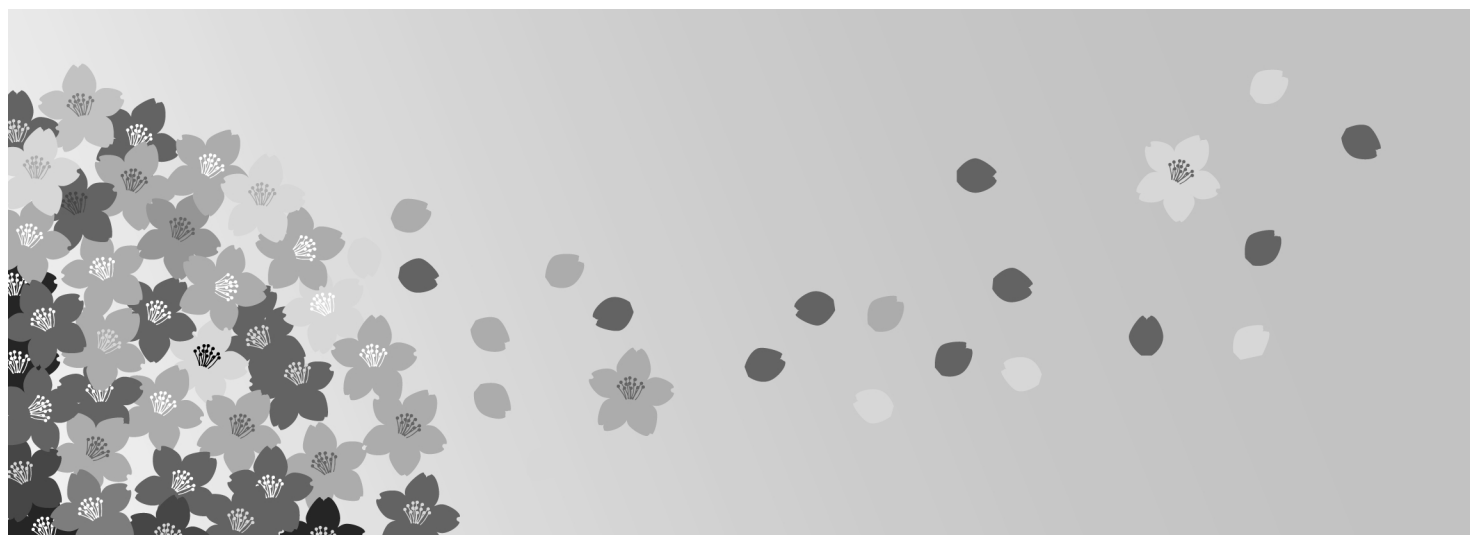

RCS-SH80UG

1

SEMI-CONCEALED	CEILING-MOUNTED	WALL-MOUNTED	CONCEALED DUCT
(4-WAY)			
XH1242		KH1242	UH1242
XH1842		KH1842	UH1842
XH2442	TH2442	KH2442	UH2442
XH3642	TH3642	KH3632	UH3642
XH4242	TH4242		

Split System Air Conditioner

• **INSTRUCTION MANUAL**

Contents

	Page
Product Information	2
Alert Symbols	2
Installation Location	3
Electrical Requirements	3
Safety Instructions	3
Names of Parts	4
Remote Control Unit	5
Operation	9
Adjusting the Airflow Direction	10
Special Remarks	12
Setting the Timer	13
Care and Cleaning	15
Troubleshooting	17
Tips for Energy Saving	17

Product Information

If you have problems or questions concerning your Air Conditioner, you will need the following information. Model and serial numbers are on the nameplate on the bottom of the cabinet.

Model No. _____ Serial No. _____

Date of purchase _____

Dealer's address _____

Phone number _____

Alert Symbols

The following symbols used in this manual, alert you to potentially dangerous conditions to users, service personnel or the appliance:



WARNING

This symbol refers to a hazard or unsafe practice which can result in severe personal injury or death.



CAUTION

This symbol refers to a hazard or unsafe practice which can result in personal injury or product or property damage.

Installation Location

- We recommend that this air conditioner be installed properly by qualified installation technicians in accordance with the Installation Instructions provided with the unit.
- Before installation, check that the voltage of the electric supply in your home or office is the same as the voltage shown on the nameplate.



WARNING

- Do not install this air conditioner where there are fumes or flammable gases, or in an extremely humid space such as a greenhouse.
- Do not install the air conditioner where excessively high heat-generating objects are placed.

Avoid:

To protect the air conditioner from heavy corrosion, avoid installing the outdoor unit where salty sea water can splash directly onto it or in sulphurous air near a spa.

Electrical Requirements

1. All wiring must conform to the local electrical codes. Consult your dealer or a qualified electrician for details.
2. Each unit must be properly grounded with a ground (or earth) wire or through the supply wiring.
3. Wiring must be done by a qualified electrician.



CAUTION

To warm up the system, the power mains must be turned on at least five (5) hours before operation. Leave the power mains ON unless you will not be using this appliance for an extended period.

Power mains

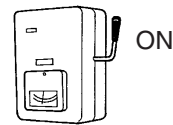

Safety Instructions

- Read this Instruction Manual carefully before using this air conditioner. If you still have any difficulties or problems, consult your dealer for help.
- The air conditioner is designed to give you comfortable room conditions. Use this only for its intended purpose as described in this Instruction Manual.



WARNING

- Never touch the unit with wet hands.
- Never use or store gasoline or other flammable vapor or liquid near the air conditioner — it is very dangerous.
- This air conditioner has no ventilator for intaking fresh air from outdoors. You must open doors or windows frequently when you use gas or oil heating appliances in the same room, which consume a lot of oxygen from the air. Otherwise there is a risk of suffocation in an extreme case.



CAUTION

- Do not turn the air conditioner on and off from the power mains switch. Use the ON/OFF operation button.
- Do not stick anything into the air outlet of the outdoor unit. This is dangerous because the fan is rotating at high speed.
- Do not let children play with the air conditioner.
- Do not cool or heat the room too much if babies or invalids are present.

Names of Parts

INDOOR UNIT

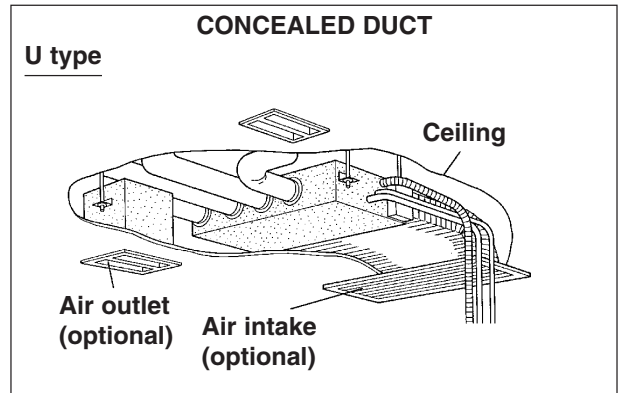
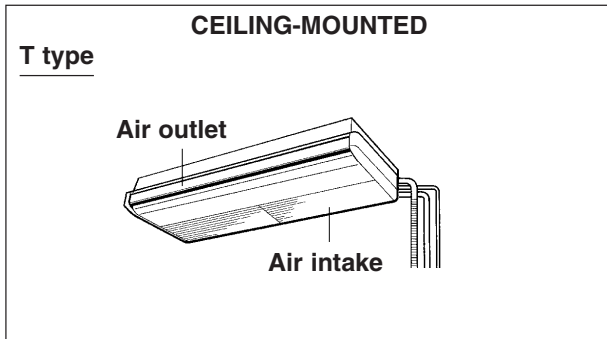
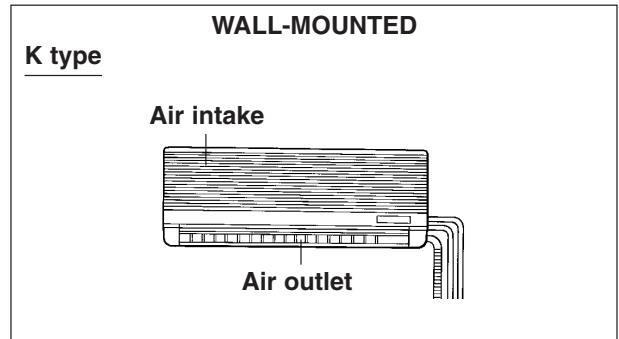
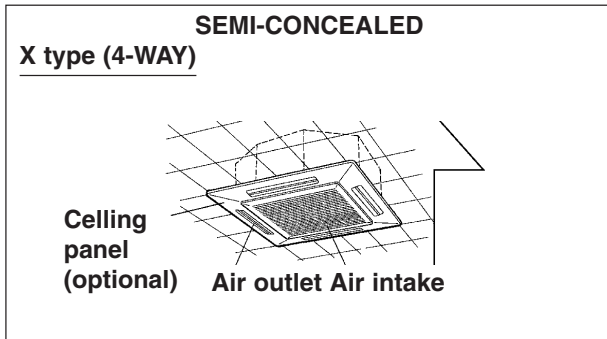

REMOTE CONTROL UNITS (optional)

(Wired type:
available for all
indoor units)



**System Remote
Controller**



Weekly Timer



(Wireless type:
available for
X and T)

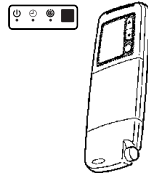

(Wireless type:
available for
K and U)

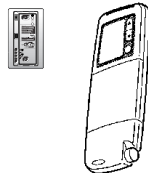









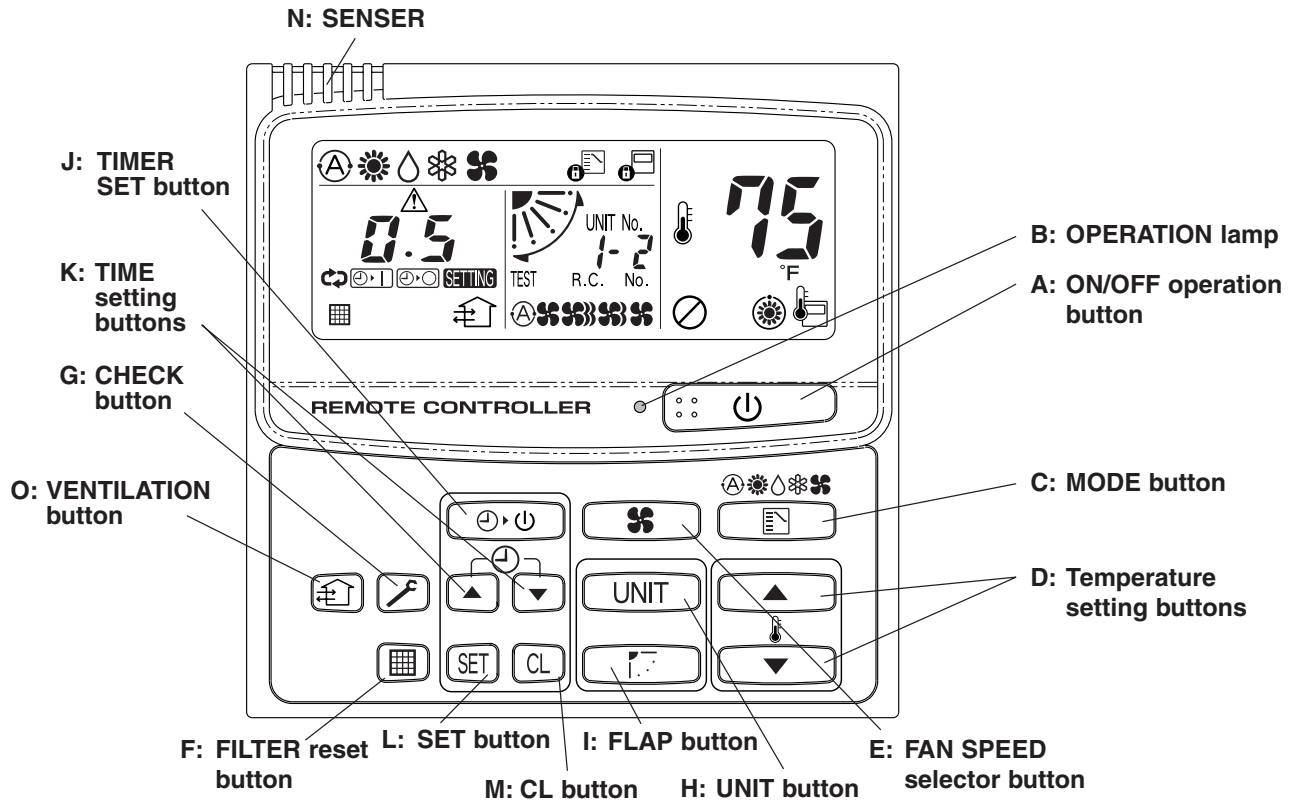







NOTE

This illustration is based on the external appearance of a standard model. Consequently, the appearance may differ from that of the air conditioner you have selected.

Remote Cotrol Unit

- With this remote controller, you can operate indoor units up to 8 units.
- Once you set your operation conditions, you can operate the units only by pressing the ON/OFF operation button.
- For the U type, the flap position is not shown on the display.























A: ON/OFF operation button 	This button is for turning the air conditioner on and off.
B: Operation lamp	This lamp lights when the air conditioner is turned on.
C: MODE button 	Use this button to select one of the following five operations: (AUTO)  : Used to automatically set cooling or heating operation. Only for heat pump type (temperature range: 62 ~ 80 °F) (HEAT)  : Used for normal heating operation. Only for heat pump type (temperature range: 60 ~ 78 °F) (DRY)  : Used for dehumidifying without changing the room temperature. (temperature range: 64 ~ 86 °F) (COOL)  : Used for normal cooling operation. (temperature range: 64 ~ 86 °F) (FAN)  : Used to run the fan only, without heating or cooling operation.
D: Temperature setting buttons 	 : Press this button to increase the temperature setting.  : Press this button to decrease the temperature setting.
E: FAN SPEED selector button 	(AUTO)  : The air conditioner automatically decides the fan speed. (HI.)  : High fan speed. (MED.)  : Medium fan speed. (LO.)  : Low fan speed.

NOTE

When low fan speed is selected and the air conditioner is in cooling operation at a low outdoor temperature of less than 50°F, the air conditioner may automatically switch to medium fan speed.

Remote Control Unit (continued)

F: FILTER reset button 	Use this button to reset the filter sign  . The air conditioner has a timer for the filter and informs you when the filter needs cleaning.												
G: CHECK button   CAUTION	This button is used only when servicing the air conditioner. Do not use the CHECK button for normal operation.												
H: UNIT button 	When more than one indoor unit is connected, this button is used to select a unit when adjusting the airflow direction. If no unit is selected, the airflow direction of all units can be adjusted concurrently using the FLAP button.												
I: FLAP button  (↙)  CAUTION NOTE  NOTE	1. Use this button to set the airflow direction to a specific angle. The airflow direction (↙) is displayed on the remote control unit. <table border="0" style="width: 100%;"> <thead> <tr> <th style="text-align: left;">Operation mode</th> <th style="text-align: left;">Number of airflow direction settings</th> </tr> </thead> <tbody> <tr> <td>❄ (COOL) or ∆ (DRY)</td> <td>3</td> </tr> <tr> <td>☀ (HEAT) or 🌀 (FAN)</td> <td>5</td> </tr> <tr> <td>Ⓐ (AUTO)</td> <td></td> </tr> <tr> <td style="padding-left: 20px;">Cooling mode:</td> <td>3</td> </tr> <tr> <td style="padding-left: 20px;">Heating mode:</td> <td>5</td> </tr> </tbody> </table> <ul style="list-style-type: none"> • In the cool mode and dry mode, when the flaps are set in a downward position, condensation may form and drip around the vent. • Do not move the flap with your hands. This function is available only for models X and T. 2. Use this button to make the airflow direction sweep up and down automatically. Press this button several times until the (↻) symbol appears on the display. This function is available only for models X, T and K.	Operation mode	Number of airflow direction settings	❄ (COOL) or ∆ (DRY)	3	☀ (HEAT) or 🌀 (FAN)	5	Ⓐ (AUTO)		Cooling mode:	3	Heating mode:	5
Operation mode	Number of airflow direction settings												
❄ (COOL) or ∆ (DRY)	3												
☀ (HEAT) or 🌀 (FAN)	5												
Ⓐ (AUTO)													
Cooling mode:	3												
Heating mode:	5												
J: TIMER SET button  (OFF Timer) (OFF Cycle Timer) (ON Timer)	Use this button while the unit is operating to switch between timer settings:  :The air conditioner stops after the length of time set.  :The air conditioner after the same set time every time.  :The air conditioner starts after the length of time set.												
K: Time setting buttons 	 :Press this button to increase the time.  :Press this button to decrease the time.												
L: SET button 	Use this button to set the timer.												
M: CL button 	Use this button to clear the timer setting.												
N: Temperature sensor of the remote controller	While the temperature sensor of the indoor unit usually detects ambient temperatures, it is also possible to detect temperatures around the remote controller. For the detail of this functionality, consult your dealer. (Do not use this functionality for group operation.)												
O: VENTILATION button 	Use this button when you installed a fan available in the market. Pressing this button turns on and off the fan. When turning off the air conditioner, the fan will be also turned off. While the fan is operating,  will appear in the display. If  is displayed when pressing the ventilation button, no fans are installed.												

Remote Control Unit (continued)

NOTE

- 1) When two remote control units are being used in one group control* system,
 - a) the most recent button that is pressed on any remote control unit is effective.
 - b) either a main-remote control unit or a sub-remote control can set the timer.
 - *Group control means that maximum up to 8 indoor units can be concurrently controlled with a remote control unit.
- 2) If a power failure occurs in timer mode, the time counted up to that point will be stored in memory. After power is restored, the timer starts again counting up to the set time.

Display (Remote Control Unit)

When you first turn on the ON/OFF operation button, **SETTING** will blink on the display of the remote controller. During this blinking, the remote controller is verifying units connected. Use the remote controller, after stops blinking.

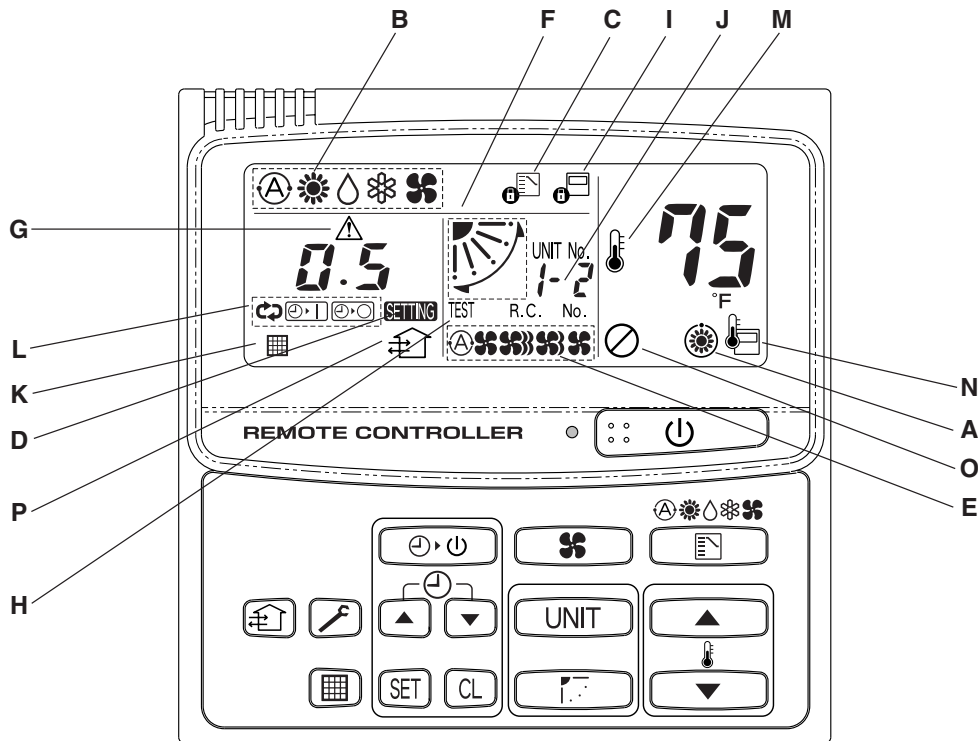

Description

- 1**
- A:** When the unit is in the heating standby mode, the ☀️❄️ indicator appears. (Refer to the description of the Special Remarks on page 12.)
 - B:** The currently selected operation mode is displayed.
 - C:** This is displayed when a different operation mode was already selected by another remote control unit and indicates that the mode cannot be changed.
 - D:** When the TIMER SET button is pressed to set the timer, the **SETTING** indicator flashes.
 - E:** The currently selected FAN SPEED is displayed.
 - F:** The currently selected Airflow Direction and SWEEP status are displayed.
 - G:** This is displayed only when an abnormality occurs within a unit.
 - H:** When the CHECK button is pressed, the TEST indicator appears.
 - I:** This is displayed to indicate that the system controller is being used for control.

When 📡 is flashing on the display, the operation is not accepted by the system controller.

- J:** This indicates the indoor unit address in case of group control.
Unit No.

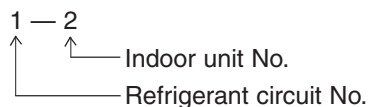

- K:** This is displayed when it is time to clean the filter.
- L:** When setting the timer, the selected timer mode is displayed.
- M:** This indication appears when the temperature is set.
- N:** This indication appears when the remote control sensor is used.
- O:** This indication appears when the ventilation fan does not operate even if the ventilation button has been pressed.
- P:** This indication appears when the ventilation fan is operating.

Operation

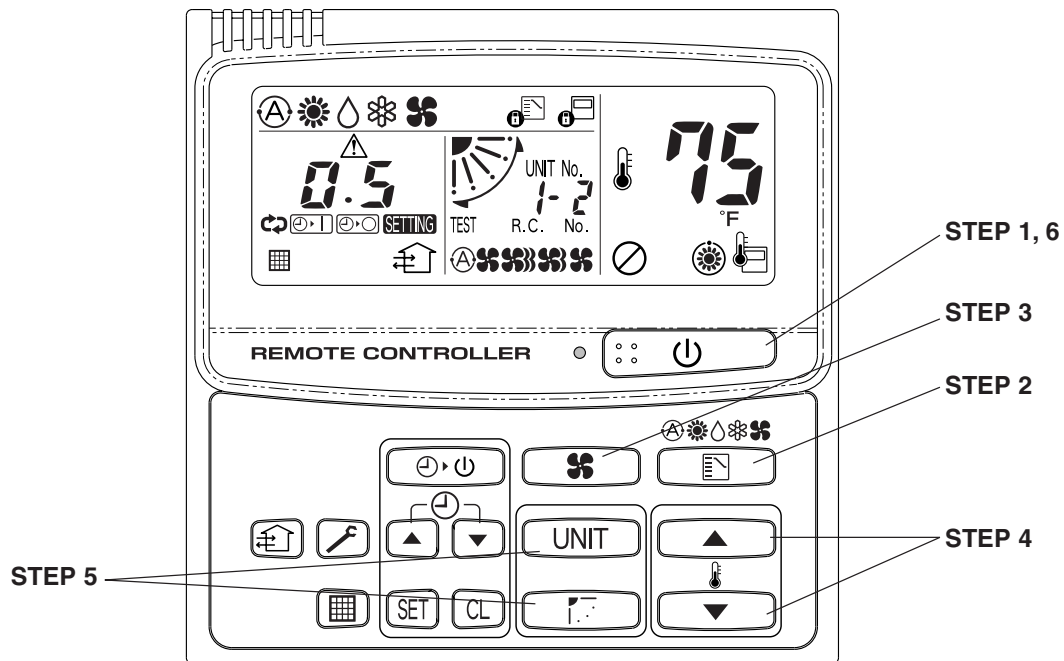

NOTE

To warm up the system, the power mains must be turned on at least five (5) hours before operation.

- STEP 1 To start the air conditioner**
Press the operation button (ON/OFF button).
- STEP 2 Setting the mode**
Press the MODE button to select the mode of your choice.
[Ⓐ (AUTO), ☀ (HEAT), ⚪ (DRY), ❄ (COOL) or 🌀 (FAN)]
- STEP 3 Setting the fan speed**
Press the FAN SPEED selector button to select the fan speed of your choice.
[🌀❄ (AUTO), 🌀❄❄ (HI.), 🌀❄❄❄ (MED.) or 🌀❄ (LO.)]
If AUTO is selected, the fan speed switches automatically.
- STEP 4 Setting the temperature**
Use the ▼ or ▲ button as appropriate to change the temperature setting as desired.
(▼ reduces the temperature, and ▲ increases the temperature.)
- STEP 5 Setting the airflow direction**
When more than one indoor unit is connected, the UNIT button is used first to select a unit. Then use the FLAP button to set the airflow direction to a specific angle or to sweep. (Refer to the description of the remote control unit.)
- STEP 6 To stop the air conditioner**
Press the operation button (ON/OFF button) again.

Adjusting the Airflow Direction

■ Semi-concealed type

4-way type (X)

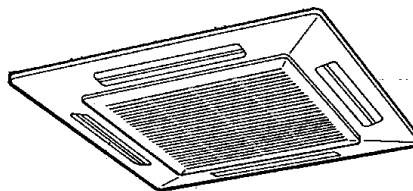

This air conditioner is equipped with auto flaps. You can set the airflow direction to a specific angle or to the sweep mode using the remote control unit. (Refer to the description of the remote control unit.)



CAUTION Do not move the flap with your hands.

■ Ceiling mounted type (T)

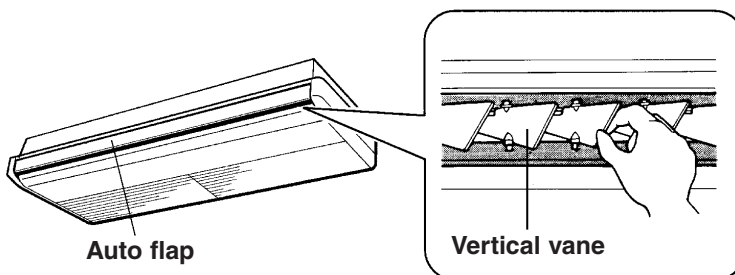

A. Vertical directions (automatic)

This air conditioner is equipped with an auto flap. You can set the airflow direction to a specific angle or to the sweep mode using the remote control unit. (Refer to the description of the remote control unit.)



CAUTION Do not move the flap with your hands.

B. Horizontal directions (manual)

The horizontal airflow direction can be adjusted manually by moving the vertical vanes to the left or right.

Adjusting the Airflow Direction (continued)

■ Wall mounted type (K)

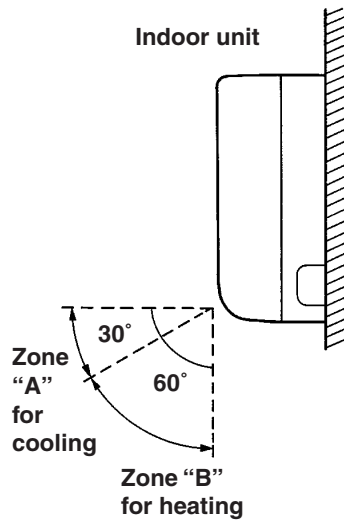

A. Vertical directions (automatic)

Confirm that the remote control unit has been turned on. Press the FLAP button to start the flap moving up and down. If you want to stop the flap movement and to direct the air in the desired direction, press the FLAP button again. In the cool mode, don't direct the flap down more than 30°, otherwise, condensation may drip on to the floor. Zone "A" is the recommended flap position for cooling.



CAUTION Do not move the flap with your hands.

B. Horizontal directions (manual)

The horizontal airflow can be adjusted manually by moving the vertical vanes to the left or right.

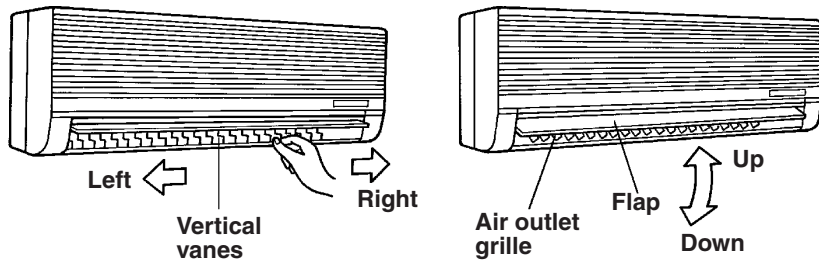

■ Concealed duct type (U)

This air conditioner is not equipped with air outlet parts. These must be obtained locally. Please refer to the manual of the locally adopted air outlet parts.

Special Remarks

“DRY” Operation

How it works

- Once the room temperature reaches the level that was set, the unit repeats the cycle of turning on and off automatically.
- In order to prevent the humidity in the room from rising again, the indoor fan also turns off when the unit stops operating.
- The fan speed is set to “LO.” automatically, and cannot be adjusted.
- “DRY” operation is not possible if the outdoor temperature is 59 °F or less.

Heating Operation



Heating performance

- Because this appliance heats a room by utilizing the heat of the outside air (heat pump system), the heating efficiency will fall off when the outdoor temperature is very low. If sufficient heat cannot be obtained with this heat pump, use another heating appliance in conjunction with this unit.

Defrosting

- When the outdoor temperature is low, frost or ice may form on the outdoor heat exchanger coil, reducing the heating performance. When this happens, a microcomputer-controlled defrosting system operates. At the same time, the fan on the indoor unit stops (or runs at very low speed in some cases) and the  (STANDBY) indicator appears on the display until defrosting is completed. Heating operation then restarts after several minutes. (This interval will vary slightly depending upon the outdoor temperature and the way in which frost forms.)

(STANDBY) on the display

- For several minutes after the start of heating operation, the indoor fan will not start running (or it will run at very low speed in some cases) until the indoor heat exchanger coil has warmed up sufficiently. This is because a cold draft prevention system is operating. During this period, the  (STANDBY) indicator remains displayed.
- The  indicator remains displayed during defrosting or when the compressor has been turned off (or when the unit is running at very low speed) by the thermostat when the system is in the heating mode.
- Upon completion of defrosting and when the compressor is turned on again,  (STANDBY) will turn off automatically as heating operation resumes.

NOTE

Should the power fail while the unit is running

If the power supply for this unit is temporarily interrupted, the unit will automatically resume operation (once the power is restored) with the same settings that were in effect before the power was interrupted.

Setting the Timer



OFF timer

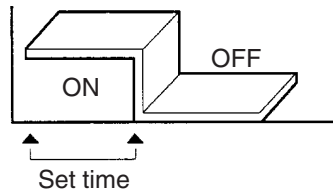

Use this mode to turn off the appliance automatically after the length of time set.



OFF cycle timer

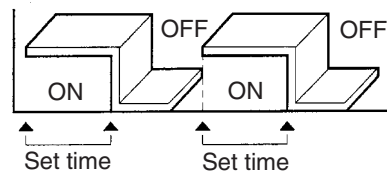

Use this mode to turn the appliance off automatically after the same set time every time.



ON timer

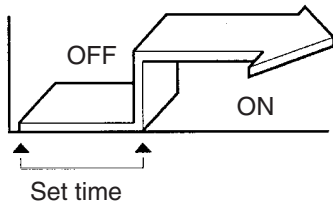

Use this mode to start the appliance automatically after the length of time set.

NOTE

When two remote control units are being used, either a main-remote control unit or a sub-remote control unit can be used for timer operations. (Refer to the description of the remote control unit.)

How to set the OFF timer (⏸)

(Example) To stop the air conditioner after 3.5 hours

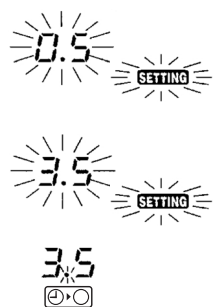

- Operation**
1. Press the **ON/OFF** button to start the air conditioner.
 2. Press the **TIMER SET** button once to select the ⏸ mode.
 3. Press the ▲ button until 3.5 is displayed. Press the ▼ button if the set time is exceeded.
 4. Press the **SET** button to set the OFF timer.



Indication

The **SETTING** and time indications (hour) flash.



The **SETTING** indication disappears and time indications (hour) flash.

How to set the OFF cycle timer (⏸⏸)

(Example) To stop the air conditioner after 3.5 hours every time

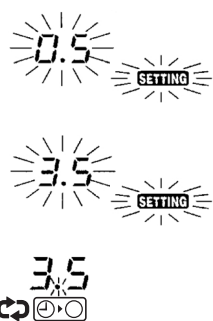

- Operation**
1. Press the **ON/OFF** button to start the air conditioner.
 2. Press the **TIMER SET** button twice to select the ⏸⏸ mode.
 3. Set the time using the ▲ or ▼ button.
 4. Press the **SET** button to set the OFF cycle timer (⏸⏸).



The **SETTING** and time indications (hour) flash.



The **SETTING** indication disappears and time indications (hour) flash.

NOTE

When the OFF cycle timer is set, the unit will stop after 3.5 hours every operation.

How to set the ON timer (⏸)

(Example) To start the air conditioner after 10.5 hours



- Operation**
1. Press the **ON/OFF** button to start the air conditioner.
 2. Press the **TIMER SET** button three times to select the ⏸ mode.
 3. Press the ▲ button until 10.5 is displayed. Press the ▼ button if the set time is exceeded.
 4. Press the **SET** button to set the ON timer.



Indication

The **SETTING** and time indications (hour) flash.



The **SETTING** and indications shown in the display disappear and time indications (hour) flash.

NOTE

When the ON timer is set, the unit enters the paused state.

How to stop the timer operation

- Operation**
- Push the **CL** button.



Indication

The **SETTING** indication disappears.

To adjust the timer

- Each press of the ▲ button increases the timer operation period with half an hour (30 minutes) step, up to 72.0 hours.
- Each press of the ▼ button decreases the timer operation period with half an hour (30 minutes) step, down to half an hour.

Care and Cleaning



WARNING

1. For safety, be sure to turn the air conditioner off and also to disconnect the power before cleaning.
2. Do not pour water on the indoor unit to clean it. This will damage the internal components and cause an electric shock hazard.

Air Intake and outlet side (Indoor Unit)

Clean the air intake and outlet side of the indoor unit with a vacuum cleaner brush, or wipe them with a clean soft cloth.

If these parts are stained, use a clean cloth moistened with a mild liquid detergent. When cleaning the air outlet side, be careful not to force the vanes out of place.

1. Never use solvents or harsh chemicals when cleaning the indoor unit. Do not wipe plastic parts using very hot water.
2. Some metal edges and the fins are sharp and may cause injury if handled improperly; be especially careful when you clean these parts.
3. The internal coil and other components of the outdoor unit must be cleaned every year. Consult your dealer or service center.

Air filter

The air filter collects dust and other particles from the air and should be cleaned at regular intervals as indicated in the table below or when the filter indication () on the display of the remote control unit (wired type) shows that the filter needs cleaning. If the filter gets blocked, the efficiency of the air conditioner drops greatly.

Type	X	T	K	U
Period	Six months	Six months	Two weeks	(depending on filter specifications)

*Concealed duct type (U):

An air filter is not provided with this air conditioner at the time of shipment. To get clean air and to extend the service life of the air conditioner, an air filter must be installed in the air intake. For installation and cleaning the air filter, consult your dealer or service center.

NOTE

The frequency with which the filter should be cleaned depends on the environment in which the unit is used.

How to clean the filter

1. Remove the air filter from the air intake grille.
2. Use a vacuum cleaner to remove light dust. If there is sticky dust on the filter, wash the filter in lukewarm, soapy water, rinse it in clean water, and dry it.

How to remove the filter

4-way semi-concealed type (X):

1. Remove the bolt screw on each side out of the latch using a screwdriver. (After cleaning, be sure to reattach the two bolt screws.)
2. Slide the two latches of the air intake grille to the direction of the arrow to open the grille.
3. Open the air intake grille downward.



CAUTION

When cleaning the air filter, never remove the safety chain. If it is necessary to remove it for servicing and maintenance inside, be sure to reinstall the safety chain securely (hook on the grille side) after the work.

Care and Cleaning (continued)

How to remove the filter (continued)

4. Remove the air filter attached to the air intake grille.

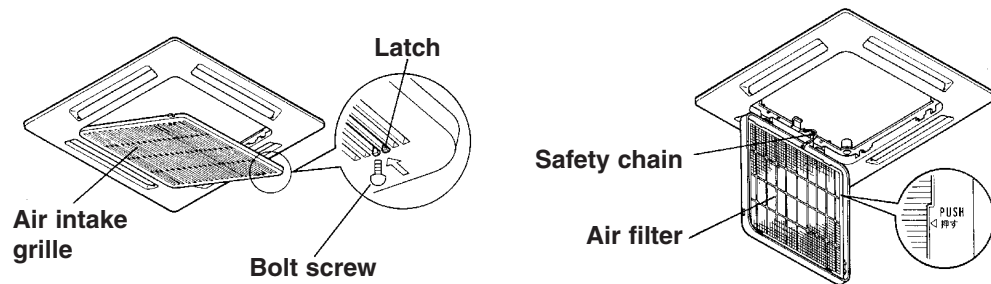

How to remove the filter (continued)

Ceiling-mounted type (T):

1. Remove the bolt screws on the finger-hold using a screw driver. (After cleaning, be sure to attach the two bolt screws.)
2. Take hold of the finger-hold on the air intake grille and slide it to the rear, and the grille will open downward.
3. Take hold of the finger-hold on the air filter, first lift it and then pull it toward you to release it from the catch.

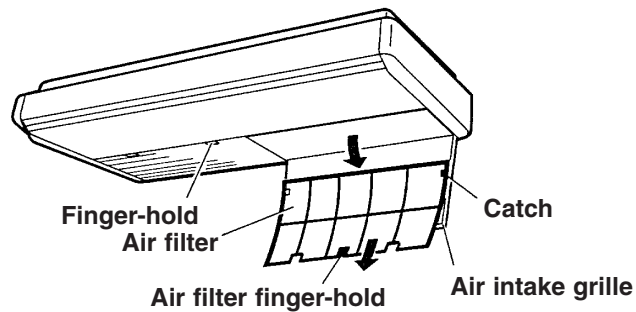

Wall-mounted type (K):

1. Move the flap on the air outlet grille to its lowest position with the remote control unit.
2. The filter is disengaged by pushing the tab up gently. Hold the air filter by the tab at the bottom, and pull downward.

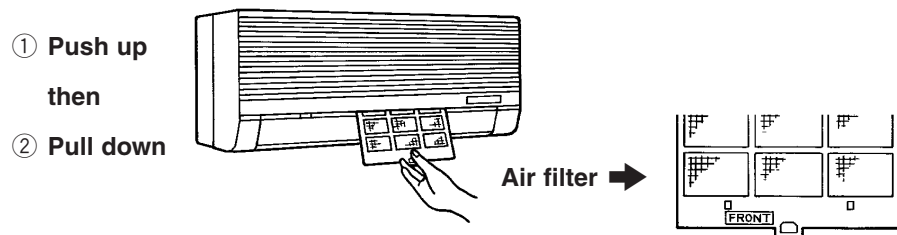

When replacing the filter, make sure that the FRONT mark is facing you. Push it up until you hear it click back into position.

Troubleshooting

If your air conditioner does not work properly, first check the following points before requesting service. If it still does not work properly, contact your dealer or a service center.

Trouble	Possible Cause	Remedy
Air conditioner does not run at all.	<ol style="list-style-type: none"> 1. Power failure 2. Leakage circuit breaker has tripped. 3. Line voltage is too low. 4. Operation button is turned off. 5. The remote control unit or heat pump is malfunctioning. (ERROR and characters such as E, F, H, L, P, etc., appear on the display.) 	<ol style="list-style-type: none"> 1. Restore power. 2. Contact service center. 3. Consult your electrician or dealer. 4. Press the button again. 5. Consult your dealer.
Compressor runs but soon stops.	<ol style="list-style-type: none"> 1. Obstruction in front of condenser coil 	<ol style="list-style-type: none"> 1. Remove obstruction.
Poor cooling (or heating) performance	<ol style="list-style-type: none"> 1. Dirty or clogged air filter 2. Heat source or many people in room 3. Doors and/or windows are open. 4. Obstacle near air intake or air discharge port 5. Thermostat is set too high for cooling (or too low for heating). 6. (Outdoor temperature is too low). 7. (Defrosting system does not work.) 	<ol style="list-style-type: none"> 1. Clean the air filter to improve the airflow. 2. Eliminate heat source if possible. 3. Shut them to keep the heat (or cold) out. 4. Remove it to ensure good airflow. 5. Set the temperature lower (or higher). 6. (Try to use a back-up heater.) 7. (Consult your dealer.)
"CHECK" is displayed.	<ol style="list-style-type: none"> 1. Trouble in the system 	<ol style="list-style-type: none"> 1. Contact service center.

1

Tips for Energy Saving

- Avoid**
- **Do not block the air intake and outlet of the unit. If either is obstructed, the unit will not work well, and may be damaged.**
 - Do not let direct sunlight into the room. Use sunshades, blinds or curtains. If the walls and ceiling of the room are warmed by the sun, it will take longer to cool the room.
- Do**
- Always try to keep the air filter clean. (Refer to "Care and Cleaning.") A clogged filter will impair the performance of the unit.
 - To prevent conditioned air from escaping, keep windows, doors and any other openings closed.

NOTE

Should the power fail while the unit is running

If the power supply for this unit is temporarily interrupted the unit will automatically resume operation (once the power is restored) with the same settings that were in effect before the power was interrupted.

Save These Instructions!

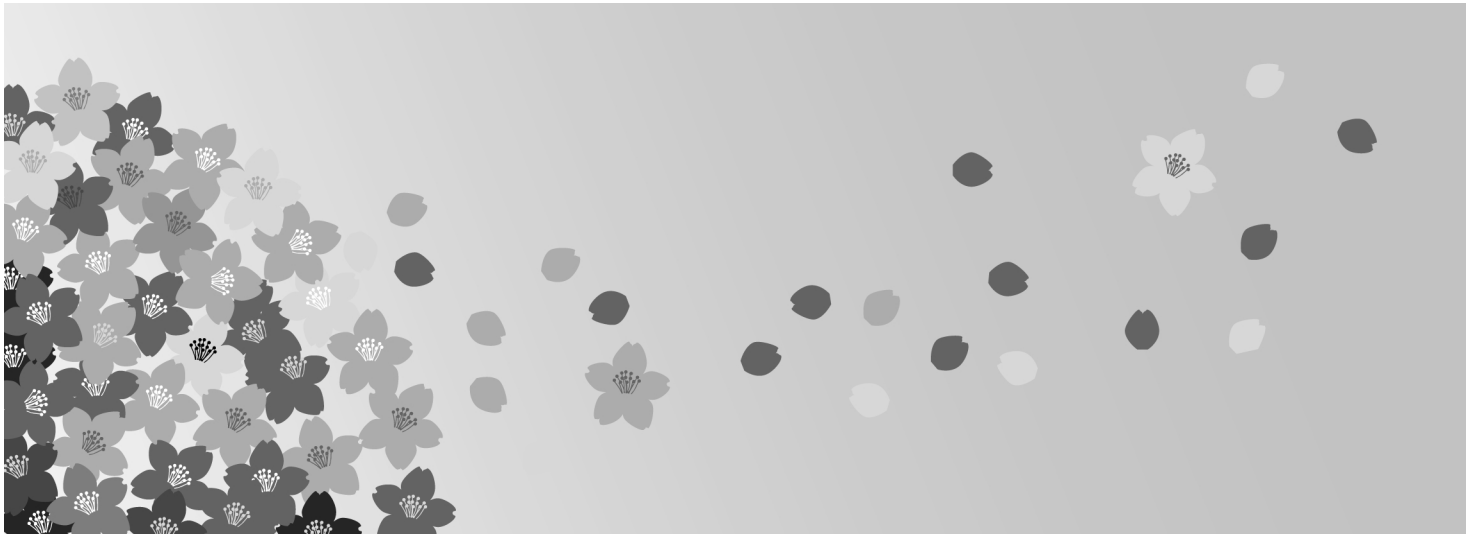

**RCS-SH80UA.WL
RCS-BH80UA.WL**

2

**Wireless Remote Controller for Split
System**

• INSTRUCTION MANUAL

For information on installing the wireless remote controller, refer to the INSTALLATION INSTRUCTIONS accompanying the outdoor unit.

Contents

	Page
Product Information	2
Alert Symbols	2
Installation Location	3
Electrical Requirements	3
Safety Instructions	3
Unit Display and Operation Controller	4
Using the Wireless Remote Controller	7
Remote Control Unit	9
Display (Wireless Remote Controller).....	12
Operation	13
Operation without the Wireless Remote Controller	14
Special Remarks.....	15
Setting the Timer	16
Troubleshooting.....	18
Tips for Energy Saving	18

Product Information

If you have problems or questions concerning your Air Conditioner, you will need the following information. Model and serial numbers are on the nameplate on the bottom of the cabinet.

Model No. _____ Serial No. _____
Date of purchase _____
Dealer's address _____
Phone number _____

Alert Symbols

The following symbols used in this manual, alert you to potentially dangerous conditions to users, service personnel or the appliance:



WARNING

This symbol refers to a hazard or unsafe practice which can result in severe personal injury or death.



CAUTION

This symbol refers to a hazard or unsafe practice which can result in personal injury or product or property damage.

Installation Location

- We recommend that this air conditioner be installed properly by qualified installation technicians in accordance with the Installation Instructions provided with the unit.
- Before installation, check that the voltage of the electric supply in your home or office is the same as the voltage shown on the nameplate.



WARNING

- Do not install this air conditioner where there are fumes or flammable gases, or in an extremely humid space such as a greenhouse.
- Do not install the air conditioner where excessively high heat-generating objects are placed.

Avoid:

To protect the air conditioner from heavy corrosion, avoid installing the outdoor unit where salty sea water can splash directly onto it or in sulphurous air near a spa.

Electrical Requirements

1. All wiring must conform to the local electrical codes. Consult your dealer or a qualified electrician for details.
2. Each unit must be properly grounded with a ground (or earth) wire or through the supply wiring.
3. Wiring must be done by a qualified electrician.



CAUTION

To warm up the system, the power mains must be turned on at least five (5) hours before operation. Leave the power mains ON unless you will not be using this appliance for an extended period.

Power mains

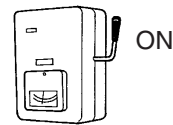

Safety Instructions

- Read this Instruction Manual carefully before using this air conditioner. If you still have any difficulties or problems, consult your dealer for help.
- The air conditioner is designed to give you comfortable room conditions. Use this only for its intended purpose as described in this Instruction Manual.



WARNING

- Never touch the unit with wet hands.
- Never use or store gasoline or other flammable vapor or liquid near the air conditioner — it is very dangerous.
- This air conditioner has no ventilator for intaking fresh air from outdoors. You must open doors or windows frequently when you use gas or oil heating appliances in the same room, which consume a lot of oxygen from the air. Otherwise there is a risk of suffocation in an extreme case.



CAUTION

- Do not turn the air conditioner on and off from the power mains switch. Use the ON/OFF operation button.
- Do not stick anything into the air outlet of the outdoor unit. This is dangerous because the fan is rotating at high speed.
- Do not let children play with the air conditioner.
- Do not cool or heat the room too much if babies or invalids are present.

Unit Display and Operation Controller for X and T Types

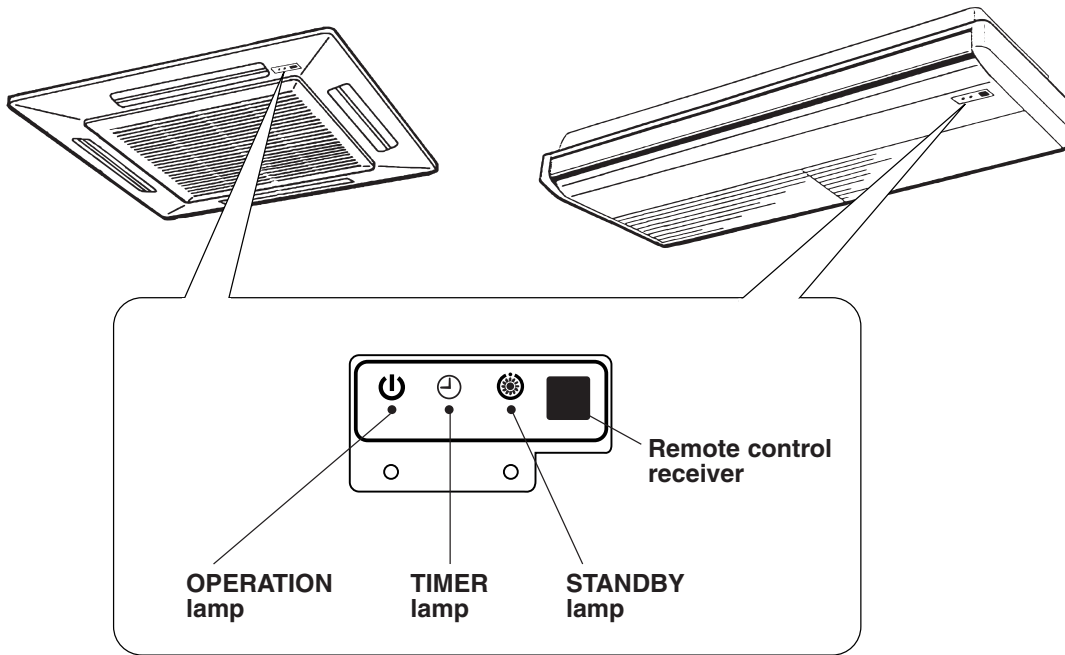

OPERATION lamp	This lamp lights when the appliance is turned on.
TIMER lamp	This lamp lights when the system is being controlled by the timer.
STANDBY lamp	When the unit is in the heating standby condition, the STANDBY lamp lights.
Remote control receiver	This section picks up infrared signals from the wireless remote controller (transmitter).
Operation controller (housed inside)	You can operate this air conditioner using the operation controller without the wireless remote controller.

2

Unit Display and Operation Controller for X and T Types (continued)

To access the operation controller:

Press on the two latches of the air intake grille with your thumb in the direction of the arrow to open the grille. And open the air intake grille downward. The Operation Controller is located in front of the electrical component box.

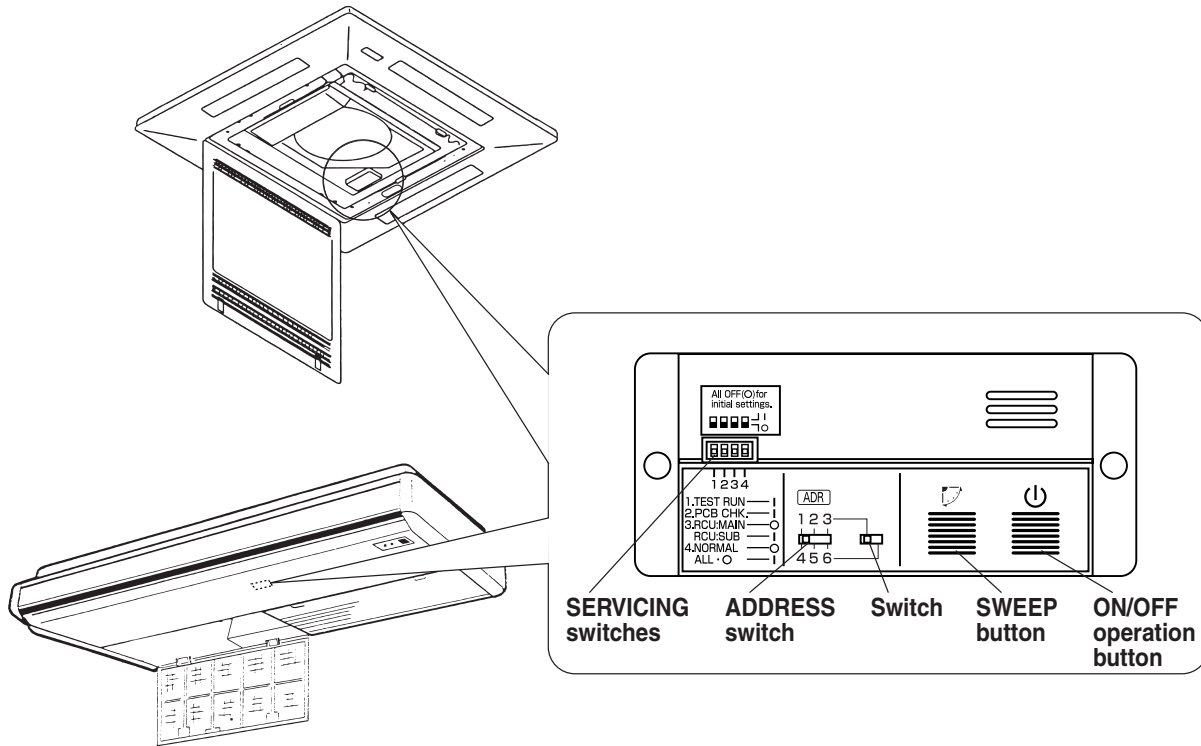

ON/OFF operation button	This button is for turning the air conditioner on and off (automatically setting cooling or heating operation).
SWEEP button	Use this button to make the airflow direction sweep up and down automatically.
Switch	Usually set this switch in to the left side.
ADDRESS switch	When operating the air conditioner by using the wireless remote controller, be sure to match the number on this switch with the number set on the wireless remote controller. Otherwise, the remote control will not work.
SERVICING switches  CAUTION	These switches are used only when servicing the air conditioner. Do not use these SERVICING switches for normal operation.



WARNING

Turning off the ON/OFF operation button does not disconnect the power. Use the main power switch to turn off the power completely.

Operation Controller with Receiver (Separated from Indoor Unit) for K and U Types

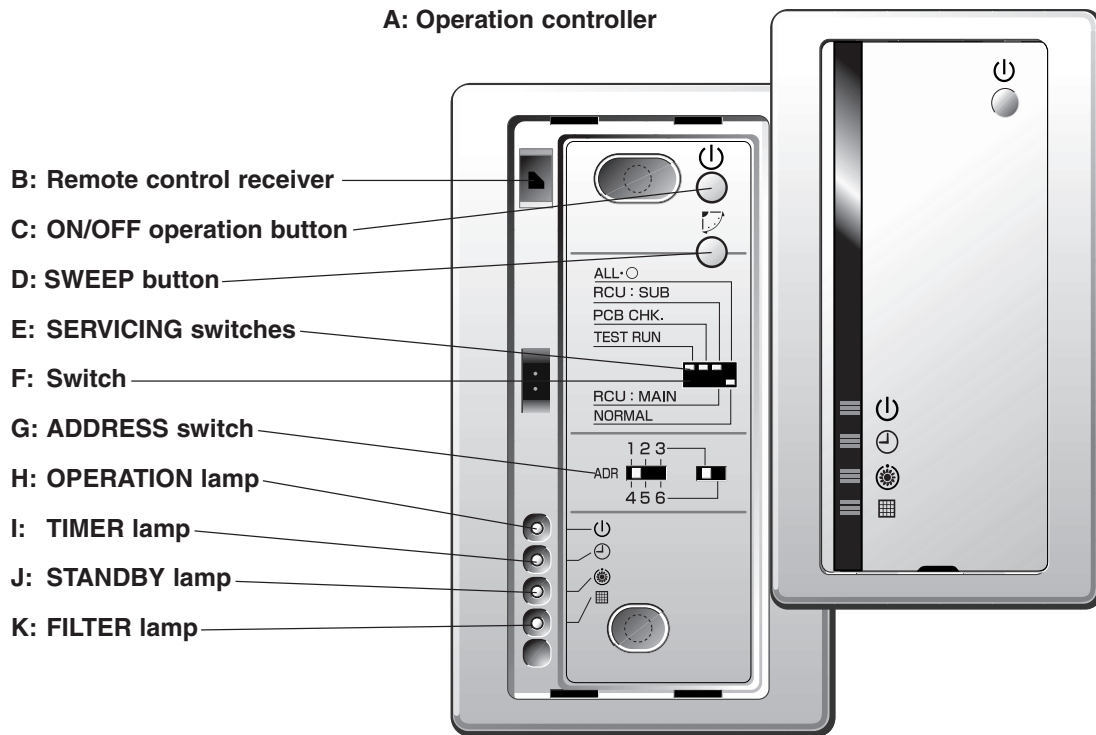

A: Operation controller (separated from indoor unit)	You can operate this air conditioner using the operation controller without the wireless remote controller.
B: Remote control receiver	This section picks up infrared signals from the wireless remote controller (transmitter).
C: ON/OFF operation button	This button is for turning the air conditioner on and off (automatically setting cooling or heating operation).
D: SWEEP button	Use this button to make the airflow direction sweep up and down automatically.
E: SERVICING switches  CAUTION	These switches are used only when servicing the air conditioner. Do not use these SERVICING switches for normal operation.
F: Switch	Usually set this switch in to the NORMAL position.
G: ADDRESS switch	When operating the air conditioner by using the wireless remote controller, be sure to match the number on this switch with the number set on the wireless remote controller. Otherwise, the remote control will not work.
H: OPERATION lamp	This lamp lights when the appliance is turned on.
I: TIMER lamp	This lamp lights when the system is being controlled by the timer.
J: STANDBY lamp	When the unit is in the heating standby condition, the STANDBY lamp lights.
K: FILTER lamp	This lamp lights when the filter needs cleaning.



WARNING

Turning off the ON/OFF operation button does not disconnect the power. Use the main power switch to turn off the power completely.

Using the Wireless Remote Controller

How to Install Batteries

1. Press and slide the lid on the back of the wireless remote controller in the direction of the arrow.
2. Install two AAA alkaline batteries (LR03). Make sure the batteries point in the direction marked in the battery compartment.
3. Press the ACL button, then replace the lid. If you press it, the current time, ON time, and OFF time are all reset to 0:00.

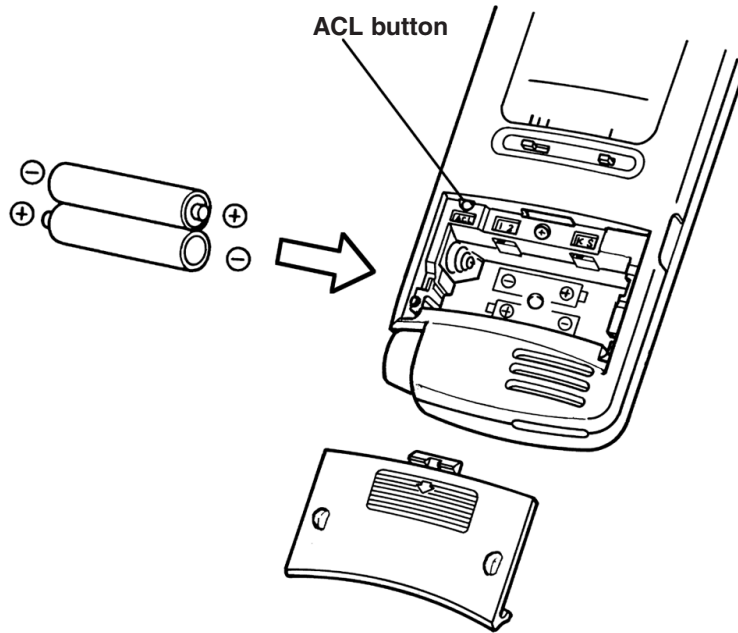

CAUTION

- The batteries last about six months, depending on how much you use the wireless remote controller. Replace the batteries when the wireless remote controller's lamp fails to light, or when the wireless remote controller cannot be used to change the air conditioner's setting.
- Use two fresh leak-proof type-AAA alkaline batteries (LR03).
- In replacing batteries, follow the instructions as mentioned in the sub-section "How to Install Batteries".
- If you do not use the wireless remote controller more than 1 month, take out the batteries.

Using the Wireless Remote Controller (continued)

How to Use the Wireless Remote Controller

When using the wireless remote controller, always point the unit's transmitter head directly at the air conditioner's receiver.

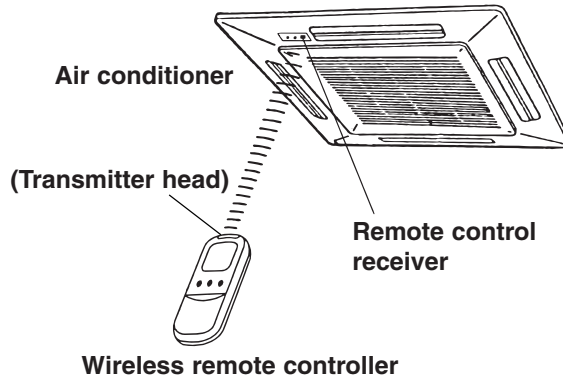

Wireless Remote Controller Installation Position

The wireless remote controller can be operated from either a non-fixed position or a wall-mounted position. To ensure that the air conditioner operates correctly, do not install the wireless remote controller in the following places:

- In direct sunlight
- Behind a curtain or other place where it is covered
- More than 26 ft away from the air conditioner
- In the path of the air conditioner's airstream
- Where it may become extremely hot or cold
- Where it may be subject to electrical or magnetic interference

1. If Non-fixed Position

Raise the rear plate of the wireless remote controller mounting cradle and insert the wireless remote controller. The unit can be used either in that position (placed on a table, for instance) or held in the hand.

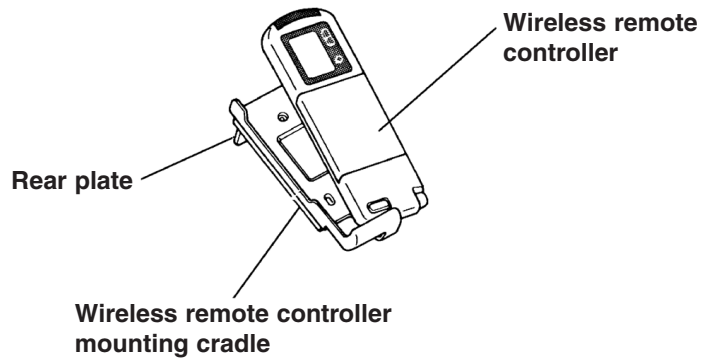





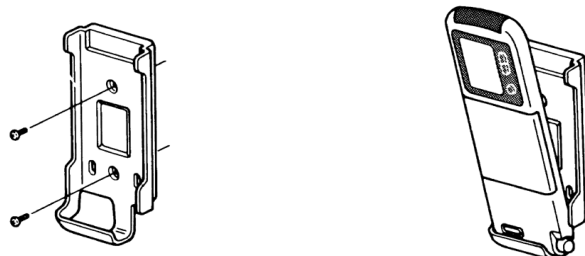

2. If Wall-mounted Fixed Position

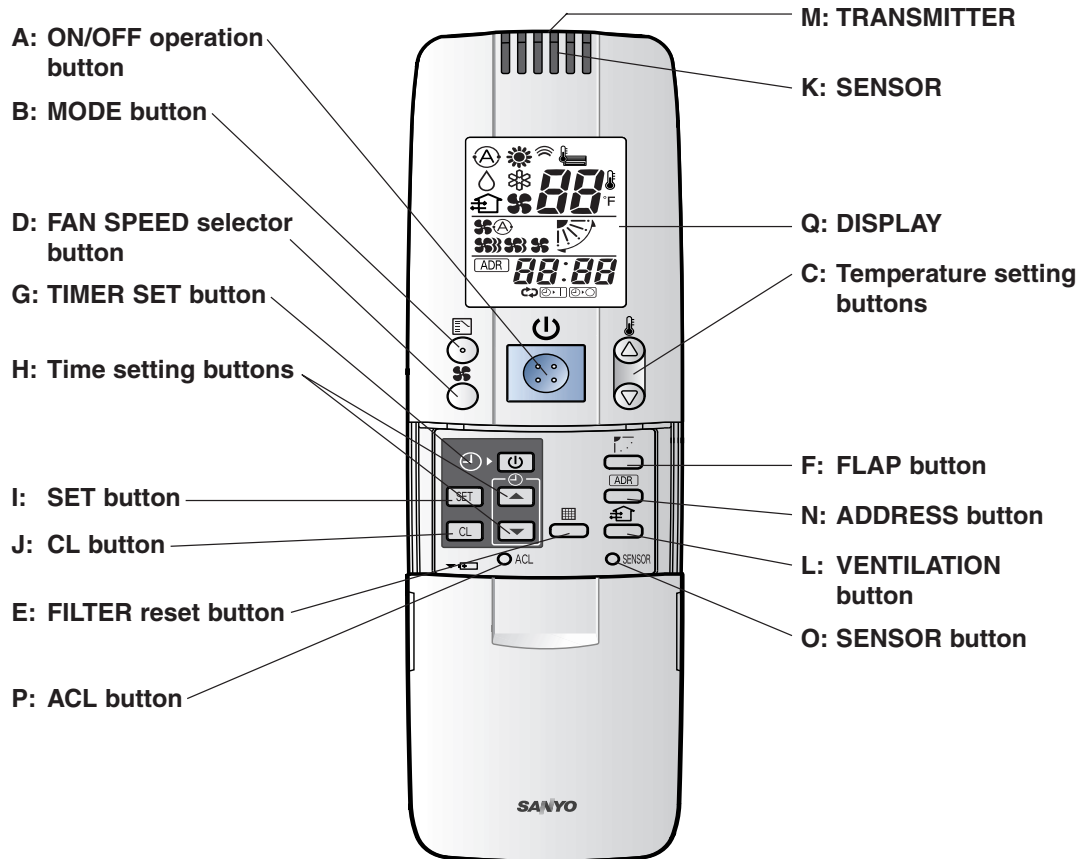
Install the wireless remote controller at a convenient location on a nearby wall. However, before attaching the wireless remote controller mounting cradle, check that the wireless remote controller can operate from the desired wall position.



Remote Control Unit





































A: ON/OFF operation button 	This button is for turning the air conditioner on and off.
B: MODE button  (AUTO) (HEAT) (DRY) (COOL) (FAN)	Use this button to select one of the following five operations: Ⓐ : Used to automatically set cooling or heating operation. Only for heat pump type (temperature range: 62 ~ 80 °F) ☼ : Used for normal heating operation. Only for heat pump type (temperature range: 60 ~ 78 °F) △ : Used for dehumidifying without changing the room temperature. (temperature range: 64 ~ 86 °F) ✱ : Used for normal cooling operation. (temperature range: 64 ~ 86 °F) ✱Ⓐ : Used to run the fan only, without heating or cooling operation.
C: Temperature setting buttons 	△ : Press this button to increase the temperature setting. ▽ : Press this button to decrease the temperature setting.
D: FAN SPEED selector button  (AUTO) (HI.) (MED.) (LO.)	✱Ⓐ : The air conditioner automatically decides the fan speed. ✱ⒶⒶ : High fan speed. ✱ⒶⒷ : Medium fan speed. ✱ⒶⒸ : Low fan speed.
E: FILTER reset button 	Use this button to reset the filter sign  . The air conditioner has a timer for the filter and informs you when the filter needs cleaning.



NOTE

When low fan speed is selected and the air conditioner is in cooling operation at a low outdoor temperature of less than 50°F, the air conditioner may automatically switch to medium fan speed.

Remote Control Unit (continued)

<p>F: FLAP button </p> <div style="text-align: center;">  <p>CAUTION</p> </div> <div style="text-align: center;"> <p>NOTE</p>  </div> <div style="text-align: center;"> <p>NOTE</p> </div>	<p>1. Use this button to set the airflow direction to a specific angle. The airflow direction () is displayed on the remote control unit.</p> <table border="1" style="width: 100%; border-collapse: collapse;"> <thead> <tr> <th style="text-align: left;">Operation mode</th> <th style="text-align: left;">Number of airflow direction settings</th> </tr> </thead> <tbody> <tr> <td> (COOL) or  (DRY)</td> <td style="text-align: center;">3</td> </tr> <tr> <td> (HEAT) or  (FAN)</td> <td style="text-align: center;">5</td> </tr> <tr> <td> (AUTO)</td> <td></td> </tr> <tr> <td style="padding-left: 20px;">Cooling mode:</td> <td style="text-align: center;">3</td> </tr> <tr> <td style="padding-left: 20px;">Heating mode:</td> <td style="text-align: center;">5</td> </tr> </tbody> </table> <ul style="list-style-type: none"> • In the cool mode and dry mode, when the flaps are set in a downward position, condensation may form and drip around the vent. • Do not move the flap with your hands. <p>This function is available only for models X and T.</p>	Operation mode	Number of airflow direction settings	 (COOL) or  (DRY)	3	 (HEAT) or  (FAN)	5	 (AUTO)		Cooling mode:	3	Heating mode:	5
Operation mode	Number of airflow direction settings												
 (COOL) or  (DRY)	3												
 (HEAT) or  (FAN)	5												
 (AUTO)													
Cooling mode:	3												
Heating mode:	5												
<p>G: TIMER SET button </p> <p style="text-align: center;">(OFF Timer) (OFF Cycle Timer) (ON Timer)</p>	<p>2. Use this button to make the airflow direction sweep up and down automatically. Press this button several times until the () symbol appears on the display.</p> <p>This function is available only for models X, T and K.</p> <p>Use this button while the unit is operating to switch between timer settings:</p> <p> :The air conditioner stops after the length of time set.</p> <p> :The air conditioner after the same set time every time.</p> <p> :The air conditioner starts after the length of time set.</p>												
<p>H: Time setting buttons </p>	<p> :Press this button to increase the time.</p> <p> :Press this button to decrease the time.</p>												
<p>I: SET button </p>	<p>Use this button to set the timer.</p>												
<p>J: CL button </p>	<p>Use this button to clear the timer setting.</p>												
<p>K: SENSOR</p>	<p>A temperature sensor inside the wireless remote controller senses the room temperature when switched from a temperature sensor inside the indoor unit.</p>												
<p>L: VENTILATION button </p>	<p>Use this button when you installed a ventilation fan available in the market. Pressing this button turns on and off the fan. When turning off the air conditioner, the fan will be also turned off. While the fan is operating,  will appear in the display.</p>												
<p>M: TRANSMITTER </p>	<p>When you press the buttons on the wireless remote controller, the  mark appears in the display to transmit the setting changes to the receiver in the air conditioner.</p>												
<p>N: ADDRESS button </p>	<p>By pressing the ADDRESS button of the remote controller, the display of the remote controller indicates the current address. If this address matches with the address of the controller in an indoor unit, the buzzer will beep. The buzzer will always beep if the indicated address is "ALL". If the indicated address is "ALL", you can operate any of your indoor units regardless of their setting of controller addresses. Direct the remote controller to the remote control receiver of the indoor unit you want to operate and send a signal. (See p.11, How to set the ADDRESS.)</p>												



Remote Control Unit (continued)

<p>O: SENSOR button </p> <p style="text-align: right;">NOTE</p>	<p>Use this button to switch to the temperature sensor of the remote controller.</p> <p>The temperature sensor of the air-conditioner is selected at the factory and the display indicates  under this selection.</p> <p>If the remote controller is located near a heat source, such as a space heater or in direct sunlight, press the SENSOR button to switch to the sensor on the indoor unit.</p>
<p>P: ACL button (ALL CLEAR) </p>	<p>Puts the wireless remote controller into pre-operation status. Always press this button after replacing the batteries.</p>
<p>Q: DISPLAY</p>	<p>Information on the operating conditions is displayed while the wireless remote controller is switched on. If the unit is turned off, only the mode that was set previously is still displayed.</p>



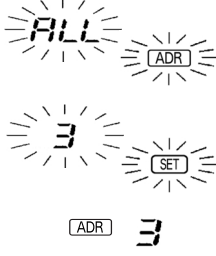

- NOTE**
- The wireless remote controller sends the temperature signal to the air conditioner regularly at three minute intervals. If the signal from the wireless remote controller stops for more than ten minutes due to the loss of the wireless remote controller or other trouble, the air conditioner will switch to the temperature sensor which is built into the indoor unit and control the room temperature. In these cases, the temperature around the wireless remote controller may differ from the temperature detected at the air conditioner's position.

How to set the ADDRESS ()

Setting addresses of indoor units for remote controller

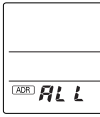
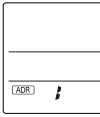
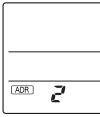
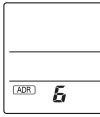
	Operation	Indication
	<ol style="list-style-type: none"> Press the ADDRESS button for more than four seconds. By each pressing the ADDRESS button, the indicated address will change from "ALL" to "1" through "6" in turn and lap to "ALL". Adjust the address switch of an indoor unit you want to operate to match its address indicated on the remote controller. Press the SET button. 	<p>➔ The display of the remote controller indicates  , and the current address appears and blinks.</p>
	<p>➔ The indicated address stops blinking and remains for five seconds.</p>	

- NOTE**
- If the set address on the remote controller matches with the controller address in an indoor unit, the buzzer will beep.

Address indication on the remote controller				
				
<p>Setting of the address switch of the controller in an indoor unit</p> <p>Match this address with the address indicated on the remote controller.</p>	<p>If the remote controller indicates "ALL":</p>  <p>You can set any address in the controller.</p>	<p>If the remote controller indicates "1":</p> 	<p>If the remote controller indicates "2":</p> 	<p>If the remote controller indicates "6":</p> 

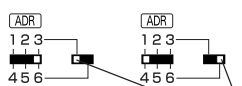

- NOTE**
- To set the address to 1, 2, or 3, switch this "SWITCH" knob to the left; to set the address to 4, 5, or 6, switch this "SWITCH" knob to the right.

SWITCH

Display (Wireless Remote Controller)

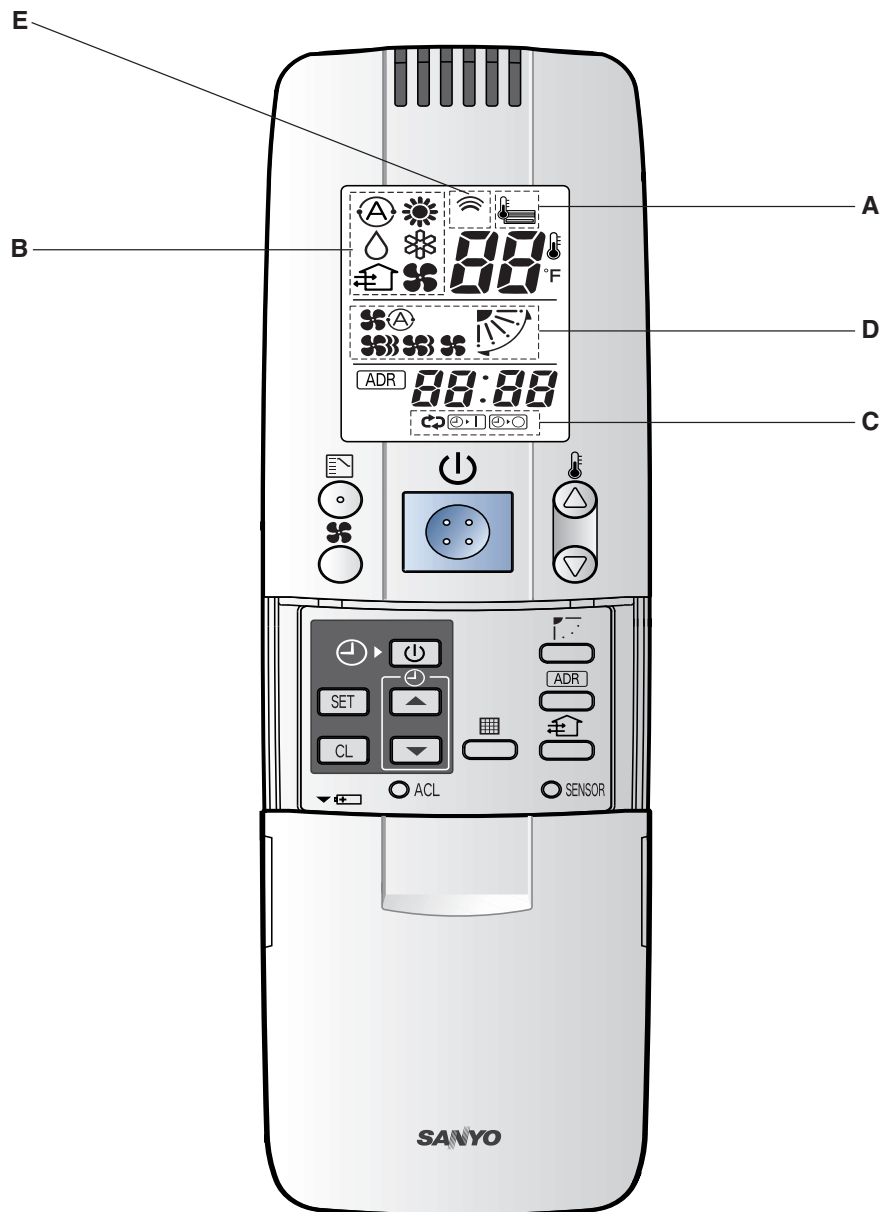

Description

- A:** When you press the SENSOR button, the  (SENSOR) indicator appears or disappears.
- B:** The currently selected operation mode is displayed.
- C:** When setting the timer, the selected timer mode is displayed.
- D:** The currently selected FAN SPEED, FLAP ANGLE and SWEEP status are displayed.
- E:** This indicator flashes when you operate the wireless remote controller.

Operation

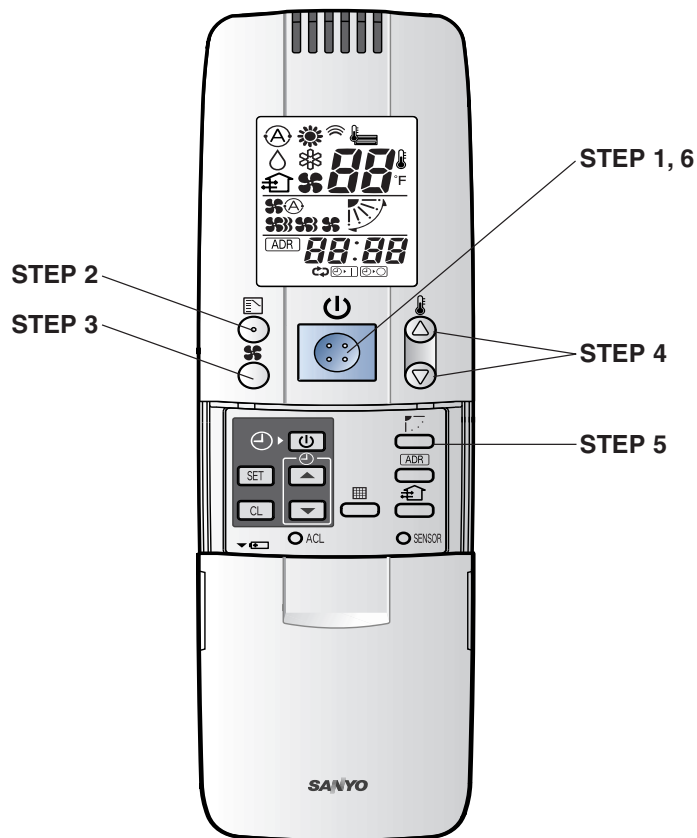

NOTE

To warm up the system, the power mains must be turned on at least five (5) hours before operation.

STEP 1 To start the air conditioner

Press the operation button (ON/OFF button).





STEP 2 Setting the mode

Press the MODE button to select the mode of your choice.

[ (AUTO),  (HEAT),  (DRY),  (COOL) or  (FAN)]



STEP 3 Setting the fan speed

Press the FAN SPEED selector button to select the fan speed of your choice.

[ (AUTO),  (HI.),  (MED.) or  (LO.)]

If AUTO is selected, the fan speed switches automatically.

STEP 4 Setting the temperature

Use the  or  button as appropriate to change the temperature setting as desired.

( reduces the temperature, and  increases the temperature.)

STEP 5 Setting the airflow direction

When more than one indoor unit is connected, the UNIT button is used first to select a unit. Then use the FLAP button to set the airflow direction to a specific angle or to sweep. (Refer to the description of the remote control unit.)

STEP 6 To stop the air conditioner

Press the operation button (ON/OFF button) again.

Operation without the Wireless Remote Controller

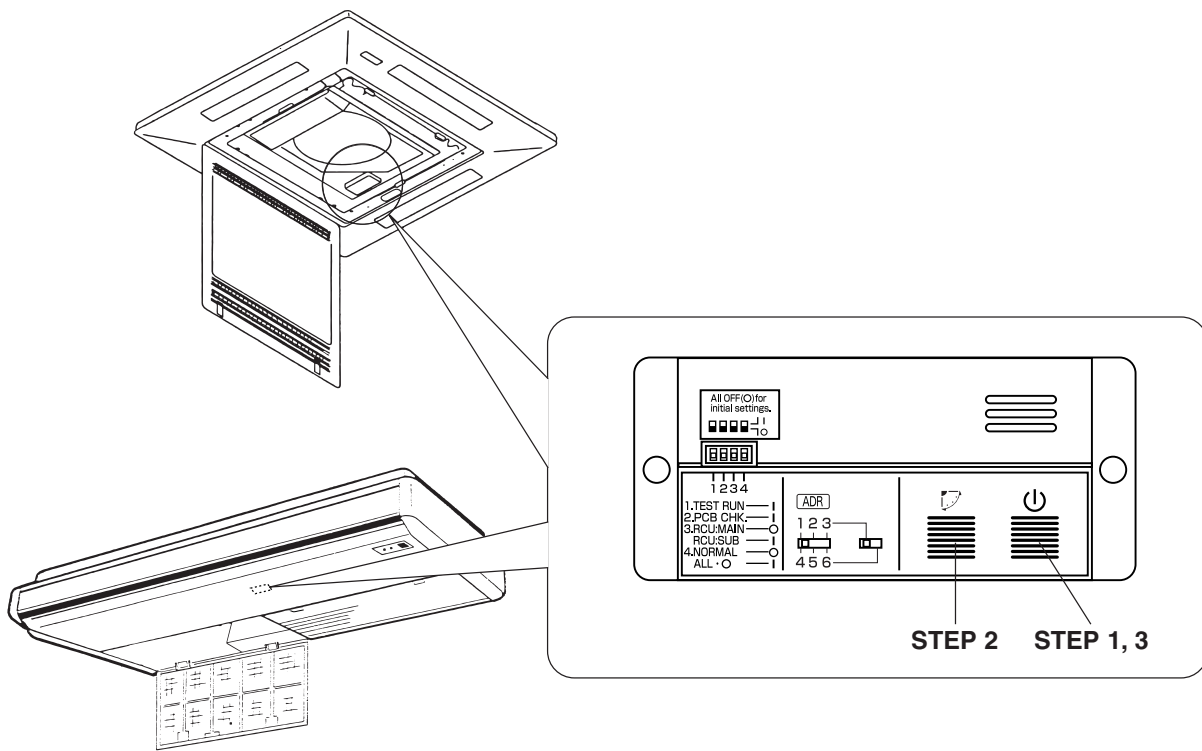

If you have lost the wireless remote controller or if it is not working properly, follow the steps below:

STEP 1 To start the air conditioner

Press the ON/OFF operation button (automatically setting cooling or heating operation).

STEP 2 Setting the airflow direction

To adjust the airflow direction, press the SWEEP button as appropriate. You can only set the airflow for all four sides in the same direction, or have each sweep.

STEP 3 To stop the air conditioner

Press the ON/OFF operation button again.

Special Remarks

Heating Operation



Heating performance

- Because this appliance heats a room by utilizing the heat of the outside air (heat pump system), the heating efficiency will fall off when the outdoor temperature is very low. If sufficient heat cannot be obtained with this heat pump, use another heating appliance in conjunction with this unit.

Defrosting

- When the outdoor temperature is low, frost or ice may form on the outdoor heat exchanger coil, reducing the heating performance. When this happens, a microcomputer-controlled defrosting system operates. At the same time, the fan on the indoor unit stops (or runs at very low speed in some cases) and the  (STANDBY) lamp lights on the indoor unit until defrosting is completed. Heating operation then restarts after several minutes. (This interval will vary slightly depending upon the outdoor temperature and the way in which frost forms.)

(STANDBY) lamp on the indoor unit

- For several minutes after the start of heating operation, the indoor fan will not start running (or it will run at very low speed in some cases) until the indoor heat exchanger coil has warmed up sufficiently. This is because a cold draft prevention system is operating. During this period, the  (STANDBY) lamp remains lit.
-  (STANDBY) lamp remains lit during defrosting or when the compressor has been turned off (or when the unit is running at very low speed) by the thermostat when the system is in the heating mode.
- Upon completion of defrosting and when the compressor is turned on again,  (STANDBY) lamp will light off automatically as the heating operation resumes.

ADDRESS switch setting

When setting up two or three air conditioners in one room, you can control the air conditioners correctly by setting the ADDRESS switches of the Operation Controllers and the Wireless Remote Controllers.

You can control the air conditioners:

- 1) with one wireless remote controller changing the ADDRESS switch setting of the wireless remote controller.
- 2) with each wireless remote controller having the ADDRESS switch set differently.

NOTE

Should the power fail while the unit is running

- If the power supply for this unit is temporarily interrupted the unit will automatically resume operation (once the power is restored) with the same settings that were in effect before the power was interrupted.
- Be sure to place the wireless remote controller where it can operate the air conditioner correctly.

Setting the Timer



OFF timer

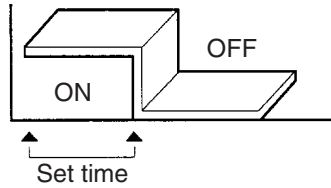

Use this mode to turn off the appliance automatically after the length of time set.



OFF cycle timer

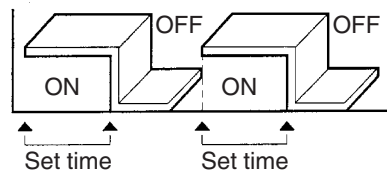

Use this mode to turn the appliance off automatically after the same set time every time.



ON timer

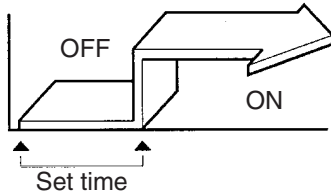

Use this mode to start the appliance automatically after the length of time set.

When two remote control units are being used, either a main-remote control unit or a sub-remote control unit can be used for timer operations. (Refer to the description of the remote control unit.)

How to set the OFF timer (⏸)

(Example) To stop the air conditioner after 3.5 hours

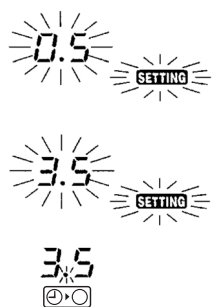

- Operation**
1. Press the **ON/OFF** button to start the air conditioner.
 2. Press the **TIMER SET** button once to select the ⏸ mode.
 3. Press the **▲** button until 3.5 is displayed. Press the **▼** button if the set time is exceeded.
 4. Press the **SET** button to set the OFF timer.



Indication

The **SETTING** and time indications (hour) flash.



The **SETTING** indication disappears and time indications (hour) flash.

How to set the OFF cycle timer (⏸⌛)

(Example) To stop the air conditioner after 3.5 hours every time

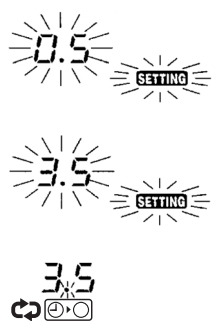

- Operation**
1. Press the **ON/OFF** button to start the air conditioner.
 2. Press the **TIMER SET** button twice to select the ⏸⌛ mode.
 3. Set the time using the **▲** or **▼** button.
 4. Press the **SET** button to set the OFF cycle timer (⏸⌛).



The **SETTING** and time indications (hour) flash.



The **SETTING** indication disappears and time indications (hour) flash.

NOTE

When the OFF cycle timer is set, the unit will stop after 3.5 hours every operation.

How to set the ON timer (⏹)

(Example) To start the air conditioner after 10.5 hours



- Operation**
1. Press the **ON/OFF** button to start the air conditioner.
 2. Press the **TIMER SET** button three times to select the ⏹ mode.
 3. Press the **▲** button until 10.5 is displayed. Press the **▼** button if the set time is exceeded.
 4. Press the **SET** button to set the ON timer.



Indication

The **SETTING** and time indications (hour) flash.



The **SETTING** and indications shown in the display disappear and time indications (hour) flash.

NOTE

When the ON timer is set, the unit enters the paused state.

How to stop the timer operation

- Operation**
- Push the **CL** button.



Indication

The **SETTING** indication disappears.

To adjust the timer

- Each press of the **▲** button increases the timer operation period with half an hour (30 minutes) step, up to 72.0 hours.
- Each press of the **▼** button decreases the timer operation period with half an hour (30 minutes) step, down to half an hour.

Troubleshooting

If your air conditioner does not work properly, first check the following points before requesting service. If it still does not work properly, contact your dealer or a service center.

Trouble	Possible Cause	Remedy
Air conditioner does not run at all.	<ol style="list-style-type: none"> 1. Power failure 2. Leakage circuit breaker has tripped. 3. Line voltage is too low. 4. Operation button is turned off. 5. The wireless remote controller or heat pump is malfunctioning. 6. Batteries in wireless remote controller have run down. 	<ol style="list-style-type: none"> 1. Restore power. 2. Contact service center. 3. Consult your electrician or dealer. 4. Press the button again. 5. Consult your dealer. 6. Replace batteries.
Compressor runs but soon stops.	<ol style="list-style-type: none"> 1. Obstruction in front of condenser coil 	<ol style="list-style-type: none"> 1. Remove obstruction.
Poor cooling (or heating) performance	<ol style="list-style-type: none"> 1. Dirty or clogged air filter 2. Heat source or many people in room 3. Doors and/or windows are open. 4. Obstacle near air intake or air discharge port 5. Thermostat is set too high for cooling (or too low for heating). 6. (Outdoor temperature is too low). 7. (Defrosting system does not work.) 	<ol style="list-style-type: none"> 1. Clean the air filter to improve the airflow. 2. Eliminate heat source if possible. 3. Shut them to keep the heat (or cold) out. 4. Remove it to ensure good airflow. 5. Set the temperature lower (or higher). 6. (Try to use a back-up heater.) 7. (Consult your dealer.)
Lamps on the indoor unit are flashing.	<ol style="list-style-type: none"> 1. Trouble in wiring system 	<ol style="list-style-type: none"> 1. Contact service center.

Tips for Energy Saving

2

- Avoid**
- **Do not block the air intake and outlet of the unit. If either is obstructed, the unit will not work well, and may be damaged.**
 - Do not let direct sunlight into the room. Use sunshades, blinds or curtains. If the walls and ceiling of the room are warmed by the sun, it will take longer to cool the room.
- Do**
- Always try to keep the air filter clean. (Refer to “Care and Cleaning.”) A clogged filter will impair the performance of the unit.
 - To prevent conditioned air from escaping, keep windows, doors and any other openings closed.

Should the power fail while the unit is running

If the power supply for this unit is temporarily interrupted the unit will automatically resume operation (once the power is restored) with the same settings that were in effect before the power was interrupted.

Save These Instructions!

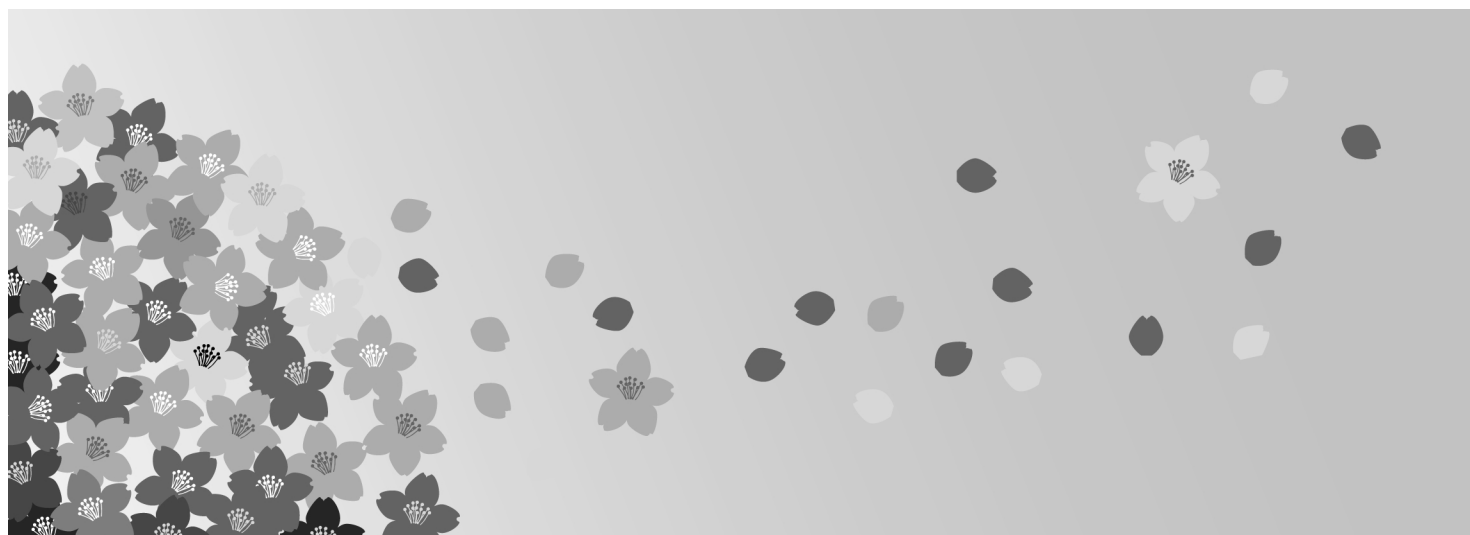

TM-SH80UG

Programmable Weekly Timer

• *INSTRUCTION MANUAL*

Contents

	Page
Product Information.....	2
Alert Symbols.....	2
Installation Location	3
Electrical Requirements	3
Safety Instructions	3
Features.....	4
Names and Functions of Controls	5
Proper Operation	6
1. Turning on.....	6
2. Turning on your air conditioner	6
3. How to set the present time.....	6
4. How to set the day.....	7
5. How to set program operations	8
6. When setting the program operation erroneously	9
7. How to duplicate programmed operation times.....	10
8. How to check programmed operation times	11
9. How to change programmed operation times	12
10. How to clear programmed operation	12
11. How to set holidays	13
Additional Information	14

Product Information

If you have problems or questions concerning your Air Conditioner, you will need the following information. Model and serial numbers are on the nameplate on the bottom of the cabinet.

Model No. _____ Serial No. _____

Date of purchase _____

Dealer's address _____

Phone number _____

Alert Symbols

The following symbols used in this manual, alert you to potentially dangerous conditions to users, service personnel or the appliance:



WARNING

This symbol refers to a hazard or unsafe practice which can result in severe personal injury or death.



CAUTION

This symbol refers to a hazard or unsafe practice which can result in personal injury or product or property damage.

Installation Location

- We recommend that this air conditioner be installed properly by qualified installation technicians in accordance with the Installation Instructions provided with the unit.
- Before installation, check that the voltage of the electric supply in your home or office is the same as the voltage shown on the nameplate.



WARNING

- Do not install this air conditioner where there are fumes or flammable gases, or in an extremely humid space such as a greenhouse.
- Do not install the air conditioner where excessively high heat-generating objects are placed.

Avoid:

To protect the air conditioner from heavy corrosion, avoid installing the outdoor unit where salty sea water can splash directly onto it or in sulphurous air near a spa.

Electrical Requirements

1. All wiring must conform to the local electrical codes. Consult your dealer or a qualified electrician for details.
2. Each unit must be properly grounded with a ground (or earth) wire or through the supply wiring.
3. Wiring must be done by a qualified electrician.



CAUTION

To warm up the system, the power mains must be turned on at least five (5) hours before operation. Leave the power mains ON unless you will not be using this appliance for an extended period.

Power mains

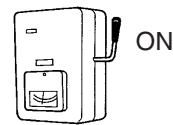

Safety Instructions

- Read this Instruction Manual carefully before using this air conditioner. If you still have any difficulties or problems, consult your dealer for help.
- The air conditioner is designed to give you comfortable room conditions. Use this only for its intended purpose as described in this Instruction Manual.



WARNING

- Never touch the unit with wet hands.
- Never use or store gasoline or other flammable vapor or liquid near the air conditioner — it is very dangerous.
- This air conditioner has no ventilator for intaking fresh air from outdoors. You must open doors or windows frequently when you use gas or oil heating appliances in the same room, which consume a lot of oxygen from the air. Otherwise there is a risk of suffocation in an extreme case.



CAUTION

- Do not turn the air conditioner on and off from the power mains switch. Use the ON/OFF operation button.
- Do not stick anything into the air outlet of the outdoor unit. This is dangerous because the fan is rotating at high speed.
- Do not let children play with the air conditioner.
- Do not cool or heat the room too much if babies or invalids are present.

Features

1. **Interactive operation allows you to control three sets of on/off time per day with an accuracy of one minute. It also enables programmed weekly operation.**
2. **By programming holidays (such as public holidays and vacations), you can cancel programmed operation for certain periods.**
3. **The present time, the present day of the week, and your programmed operation conditions are displayed with the 24-hour format.**
4. **You can turn on the unit when you need without changing your program.**
5. **Backup functionality allows you to save your program during a power failure.**

Names and Functions of Controls

Button functions and the display

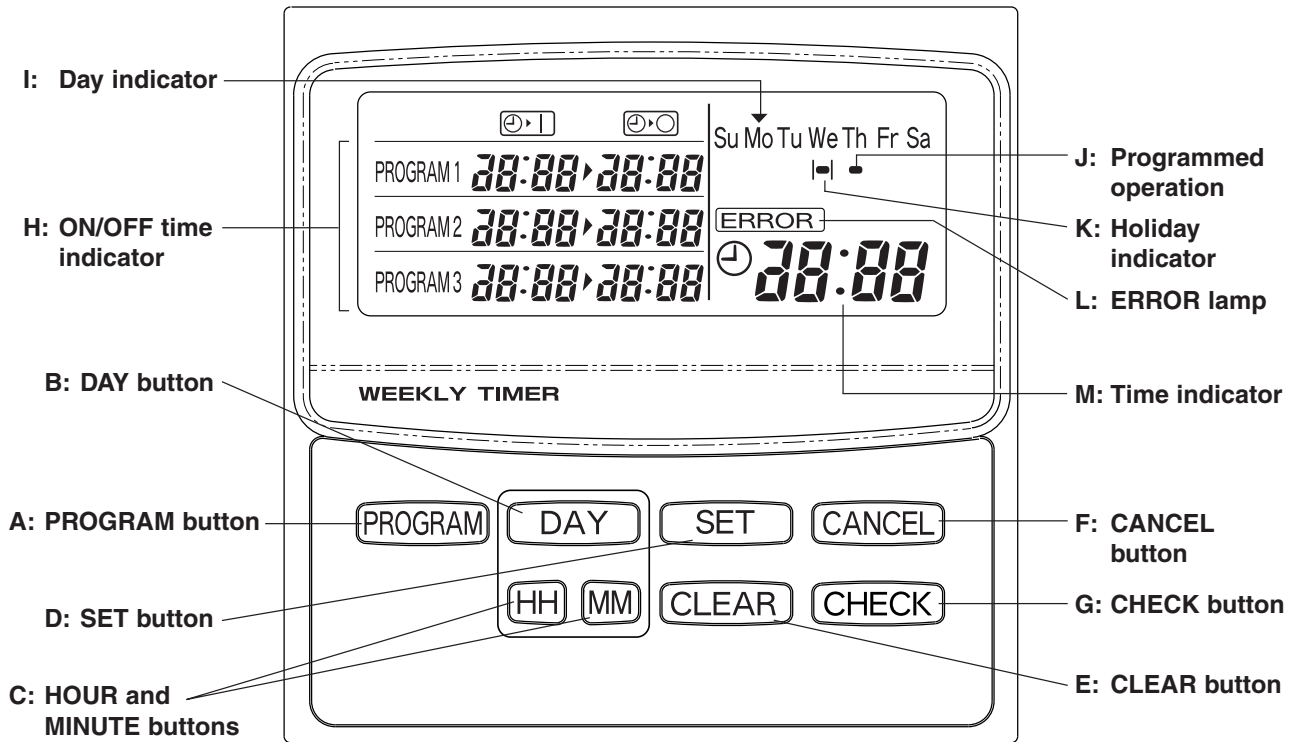

A: PROGRAM button		Use this button to program operations.
B: DAY button		Use this button to adjust the day of the week. Each press of this button moves the arrow ▼ from Su to Sa.
C: HOUR and MINUTE buttons		Use these buttons to adjust the present time and times of ON/OFF.
D: SET button		Use this button to fix your selection of the day, hour, minute, holidays, and ON/OFF time.
E: CLEAR button		Use this button to clear programs.
F: CANCEL button		Use this button to program holidays.
G: CHECK button		Use this button to confirm your program.
H: ON/OFF time indicator		Displays programmed ON/OFF times.
I: Day indicator		Displays the current day with ▼.
J: Programmed operation indicator		Displays the days of the week for which operations are programmed.
K: Holiday indicator		Displays programmed holidays.
L: ERROR lamp		This lamp lights when programs are not set properly.
M: Time indicator		Displays the present time with 24-hour format.

Proper Operation

1. Turning on

Turn on your unit.

Operation of the programmable weekly timer

Adjust the time indicator. → Adjust the day indicator. → Program a weekly operation.

2. Turn on your air conditioner that has the programmable weekly timer.

NOTE

- During cooling or heating season, do not turn off your air conditioner because the crank case heater needs to be energized to avoid damage to the compressor when turned on.
- When you turn on your air conditioner after a long period of no use, energize the unit five hours before operation.

3. How to set the present time

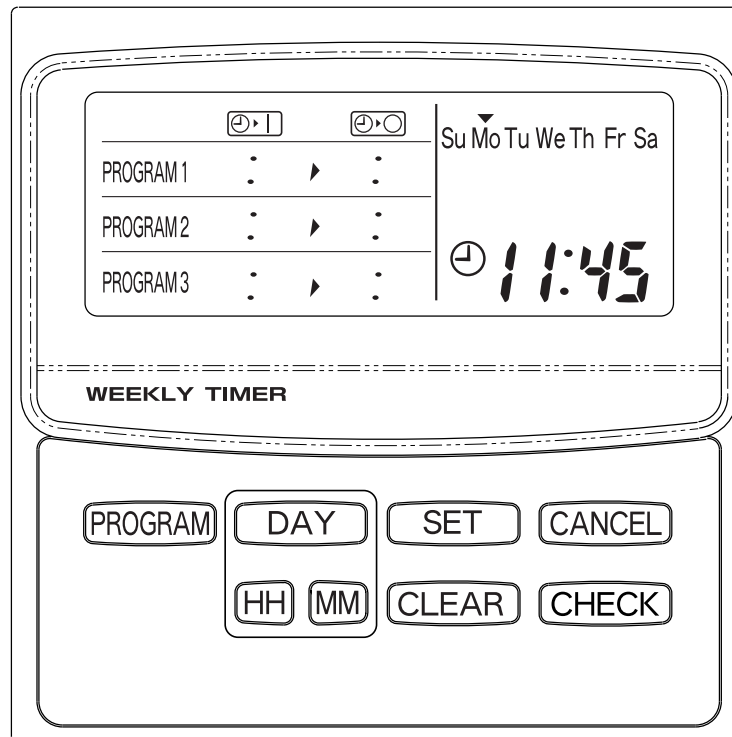

Setting the present time

(Example) To set to 11:45

STEP 1 Adjust the hour indicator by pressing the HH button while keeping the SET button pressed.

Each press of the HH button while keeping the SET button pressed increases the hour indication.

0 → 1 → ... → 10 → ... → 23 → 0

Keeping both the HH button and the SET button pressed changes the hour indication continuously.

When the indication reaches the hour to set, release the HH button.

(In the example, release the HH button when the indication reaches 11.)

By releasing the SET button, the hour indicator is fixed and stops blinking.

STEP 2 Adjust the minute indicator by pressing the MM button while keeping the SET button pressed.

Each press of the MM button while keeping the SET button pressed increases the minute indication.

00 → 01 → ... → 58 → 59 → 00

Keeping both the MM button and the SET button pressed changes the minute indication continuously.

When the indication reaches the minute to set, release the MM button.

(In the example, release the MM button when the indication reaches 45.)

By releasing the SET button, the minute indicator is fixed and stops blinking.

NOTE

- Pressing only the HH button or MM button doesn't change the time indication.
- While the time indicator is blinking, if you have not pressed the DAY button, HH button, or MM button within 30 seconds, the indicator resumes the indication not adjusted (ordinary indicator mode). To set the time again, follow above steps from the beginning.

4. How to set the day

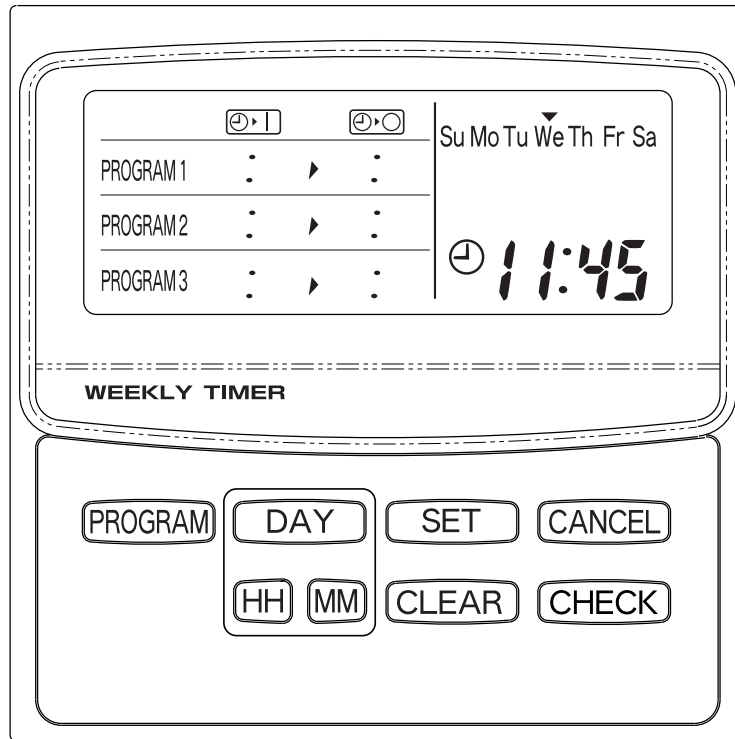

Setting the day

(Example) To set to Wednesday (We)

STEP 1 Adjust the day indicator by pressing the DAY button while keeping the SET button pressed. With each press of the DAY button while keeping the SET button pressed, the blinking day indicator (▼) moves from Su to Sa.

▼ ▼ ▼ ▼ ▼ ▼
Su Mo Tu We Th Fr Sa

When the indicator reaches the day to set, release the DAY button. By releasing the SET button, the day indicator is fixed and stops blinking.

NOTE

- Pressing only the DAY button doesn't change the day indicator.
- While the day indicator is blinking, if you have not pressed the DAY button, HH button, or MM button within 30 seconds, the indicator resumes the indication not adjusted (ordinary indicator mode). To set the day again, follow above steps from the beginning.

5. How to set program operations

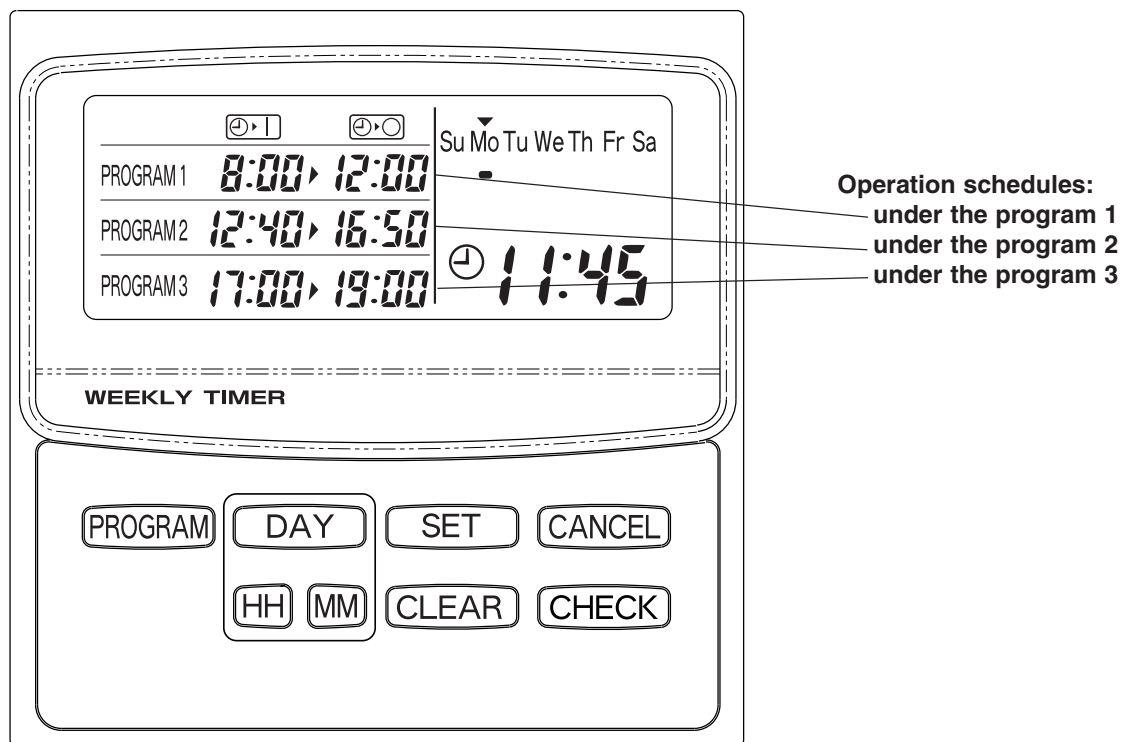

NOTE

Properly set the time and day indicators to the present time and day. Otherwise you cannot set program operations.

- 1) For each day of the week, you can set up to three sets of program operation.
- 2) You can set the following program operations:
Setting times to turn on and off. (You cannot set only times to turn on.)

(In the example below, operation on each Monday is to be programmed:
The unit should be on from 8:00 to 12:00, from 12:40 to 16:50, and from 17:00 to 19:00.)

STEP 1 Press the PROGRAM button.

When pressing the PROGRAM button, the operation reservation indicator (●) blinks.

STEP 2 Press the DAY button to select the day on which you hope to set the program operation and press the SET button.

By pressing the SET button, the operation reservation indicator stops blinking and remains lit. The ON-time indication of the PROGRAM 1 starts blinking.

STEP 3 Press the HH and MM buttons to adjust your ON-time and press the SET button.

By pressing the SET button, the ON-time indication (8:00 in the example) stops blinking and remains lit. The OFF-time indication of the PROGRAM 1 starts blinking.

STEP 4 Press the HH and MM buttons to adjust your OFF-time and press the SET button.

By pressing the SET button, the OFF-time indication (12:00 in the example) stops blinking and remains lit. The ON-time indication of the PROGRAM 2 starts blinking.

STEP 5 Subsequently, adjust the ON-times and OFF-times for the PROGRAM 2 and PROGRAM 3 taking the corresponding steps described above.

By pressing the SET button after you adjust and fix the OFF-time for the PROGRAM 3, its indication (19:00 in the example) stops blinking and remains lit. The ON-time indication of the PROGRAM 1 starts blinking.

5. How to set program operations (Continued)

STEP 6 Press the PROGRAM button to complete the program setting.

Press the PROGRAM button within 30 seconds after you finish adjusting your desired ON-times and OFF-times.

Above steps complete the program setting of operation for a day (Monday in the example). Programmed ON-time and OFF-time are displayed when the present time is within a programmed period.

(In the example, because the present time falls between the ON-time and OFF-time of the PROGRAM 1, the PROGRAM 1 content is displayed.)

STEP 7 Take the steps 1 through 6 to set program operation for other days.

If you hope to set ON-times and OFF-times that are the same with those for another day which are already programmed, refer to "7. How to duplicate programmed operation times."

NOTE

- ON-time and OFF-time adjustment

The time 0:00 is assumed to be equivalent to 24:00.

The programming shown below is acceptable.

ON-time Off-time

0:00 , *2:00*

22:00 , *0:00*

- While the ON-time or OFF-time indicator is blinking, if you have not pressed the DAY button, HH button, or MM button within 30 seconds, the indicator resumes the indication not adjusted (ordinary indicator mode). To set the program operation again, follow above steps from the beginning.

6. When setting the program operation erroneously

If the **ERROR** indicator **ERROR** blinks while you are setting program operation, take the following steps to correct times you set.

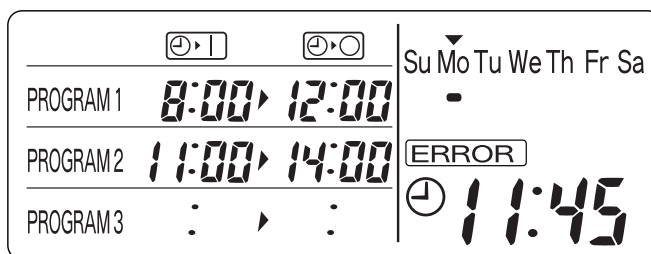

- ① While the **ERROR** blinks, the ON-time of the program operation that is incorrectly set also blinks.
- ② Press the SET button to make the time to be corrected blink.
- ③ Correct the time using the HH or/and MM button.
- ④ Press the SET button. If the corrected time is acceptable, the **ERROR** turns off.
- ⑤ Press the PROGRAM button to complete the correction.

NOTE

Programming shown below will cause ERROR setting.

- (1) Programmed operation periods overlap between programs.

Example: ON-time OFF-time

8:00 > 12:00
11:00 > 14:00

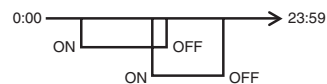

- (2) The OFF-time is earlier than the ON-time.

Example: ON-time OFF-time

12:00 > 8:00



- (3) The OFF-time and ON-time is the same.

Example: ON-time OFF-time

8:00 > 8:00

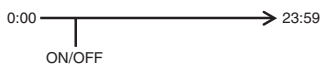

- (4) Only the ON-time or OFF-time is programmed.

Example: ON-time OFF-time

8:00 > (not programmed)

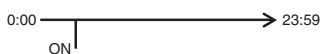

The following examples will not cause ERROR setting.

- (1) The OFF-time is the same with the ON-time of the subsequent operation period.

Example: ON-time OFF-time

8:00 > 12:00
12:00 > 19:00

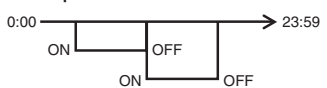

- (2) The programmed period is earlier than the preceding period.

Example: ON-time OFF-time

12:40 > 16:50
8:00 > 12:00

By pressing the PROGRAM button, programs are arranged in order of time.

Example: ON-time OFF-time

8:00 > 12:00
12:40 > 16:50

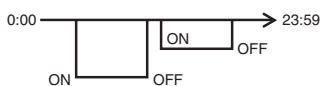

- (3) Both the ON-time and OFF-time are 0:00.

Example: ON-time OFF-time

0:00 > 0:00

* This program is for 24-hour continuous operation.

7. How to duplicate programmed operation times

If you hope to set ON-times and OFF-times that are the same with those for another day which are already programmed, you can duplicate those times.

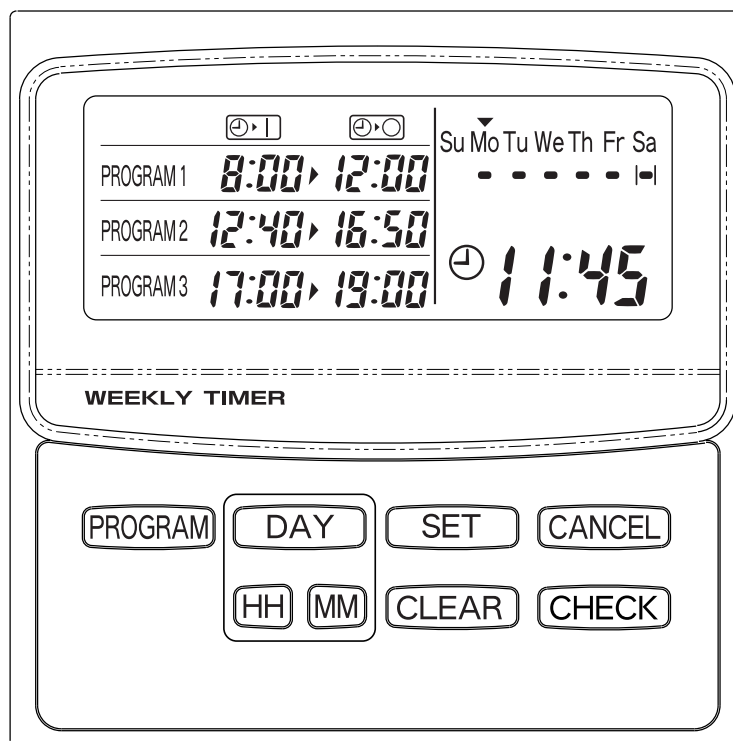

(Example) To duplicate the programmed operation on Monday to Tuesday

- ① In the ordinary indicator mode, press the CHECK button.
- ② Press the DAY button to move the operation reservation indicator (●) to the day for which the desired times are programmed (Monday in the example).
- ③ Press the PROGRAM button.
The present day indicator (▼) and operation reservation indicator (●) start blinking.
- ④ Press the DAY button to move the present day indicator (▼) to the day to which the times should be duplicated (Tuesday in the example).
If you want to duplicate the times to multiple days, press the SET button and then the DAY button for each day.
- ⑤ Press the PROGRAM button.
The operation reservation indicator (●) will be displayed beneath the day to which the times have been duplicated.

8. How to check programmed operation times

(Example) To check the Wednesday's program operation on Monday

STEP 1 Press the CHECK button.

In the ordinary indicator mode, the operation reservation indicator (●) will start blinking.

STEP 2 Press the DAY button to move the operation reservation indicator (●) to the day you want to check.

Each press of the DAY button makes the operation reservation indicator (●) blink and display the programmed operation times of the day the indicator points.

STEP 3 Press the CHECK button.

The display resumes the ordinary indicator mode.

NOTE

- While the operation reservation indicator is blinking, the display will not change by pressing any button other than the PROGRAM button.
- While the operation reservation indicator is blinking, if you have not pressed the PROGRAM button for 30 seconds, the indicator resumes the ordinary indicator mode.

9. How to change programmed operation times

- ① In the ordinary indicator mode, press the PROGRAM button.
- ② Press the DAY button to move the operation reservation indicator (●) to the day the programmed operation times of which you want to change.
- ③ Press the SET button.
- ④ By pressing the SET button, times indicators blink in turn in the order described below. Make the time to change blink.
- ⑤ Press the HH or/and MM button to change the time.
- ⑥ Press the SET button.
- ⑦ Press the PROGRAM button to complete the change.

10. How to clear programmed operation

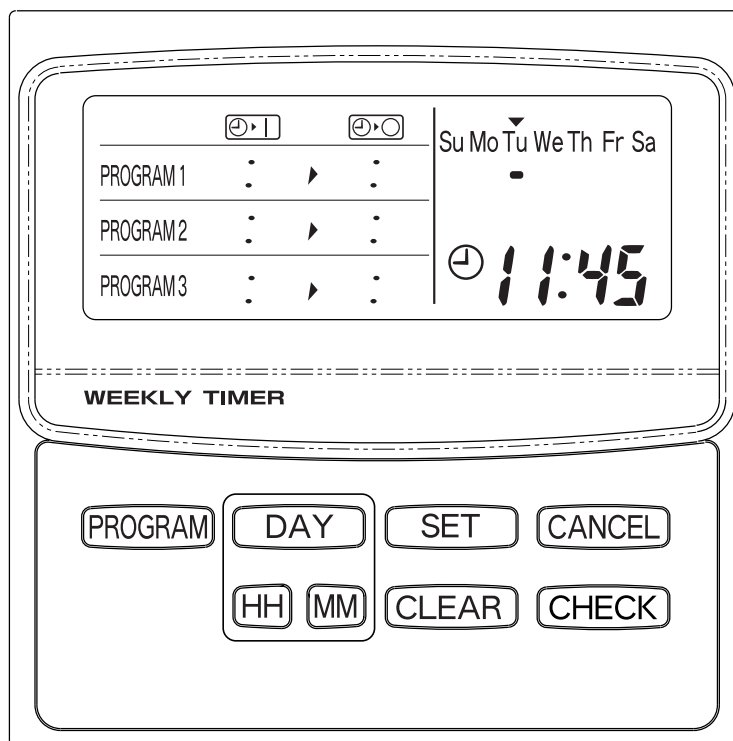

• How to clear programmed days

- ① Press the PROGRAM button.
- ② Press the DAY button to move the operation reservation indicator (●) to the day the program of which should be cleared.
- ③ Press the CLEAR button.
The programmed times for the day will turn off.
- ④ Press the PROGRAM button.
The operation reservation indicator (●) will turn off.

• How to clear a program of a day

- ① Press the PROGRAM button.
- ② Press the DAY button to move the operation reservation indicator (●) to the day a program of which should be cleared.
- ③ Press the SET button.
- ④ Press the SET button again to make the ON-time or OFF-time of the program to clear blink.
- ⑤ Press CLEAR button.
The program will be cleared and programs left will be automatically arranged to fill the cleared program.
- ⑥ Press the PROGRAM button.

11. How to set holidays

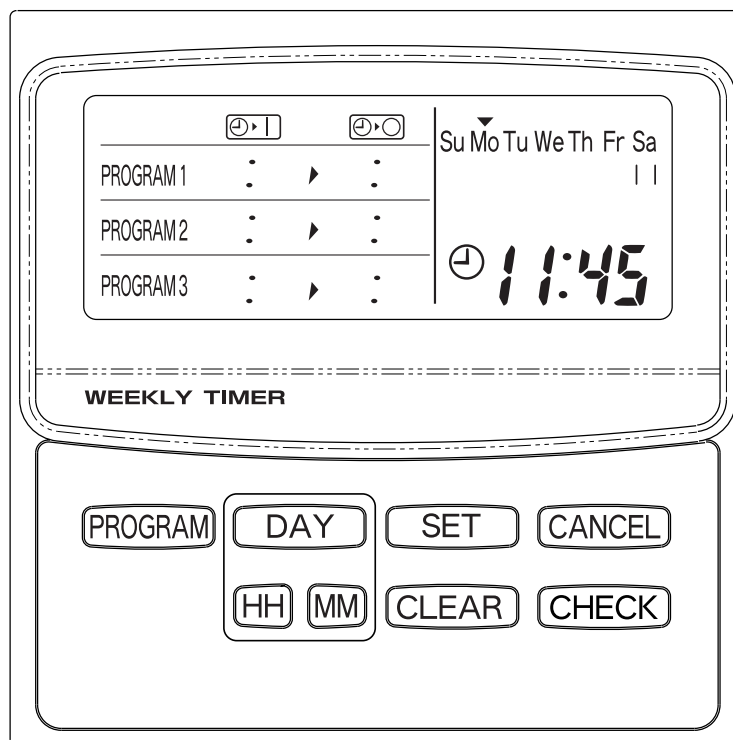

- **By using the CANCEL button, you can temporarily cancel per-day programmed operation.**
 - ① Press the CANCEL button.
The holiday indicator (| |) starts blinking.
 - ② Press the DAY button to move the holiday indicator (| |) to the day that you want to set as a holiday.
 - ③ Press the SET button.
The holiday indicator (| |) stops blinking and remains lit (|■|).
- **To clear a programmed holiday**
 - ① Press the CANCEL button.
 - ② Press the DAY button to move the holiday indicator (| |) to the day the set holiday of which you want to clear.
 - ③ Press the SET button.
The holiday indicator (|■|) will change to the operation reservation indicator (●).

Explanation of the operation

On the day that is programmed as a holiday, programmed operation does not work temporarily. Next day, the holiday indicator (| |) will change to the operation reservation indicator (●) and programmed operation resumes.

NOTE

You cannot set a holiday to a day for which no operation is programmed.

Additional Information

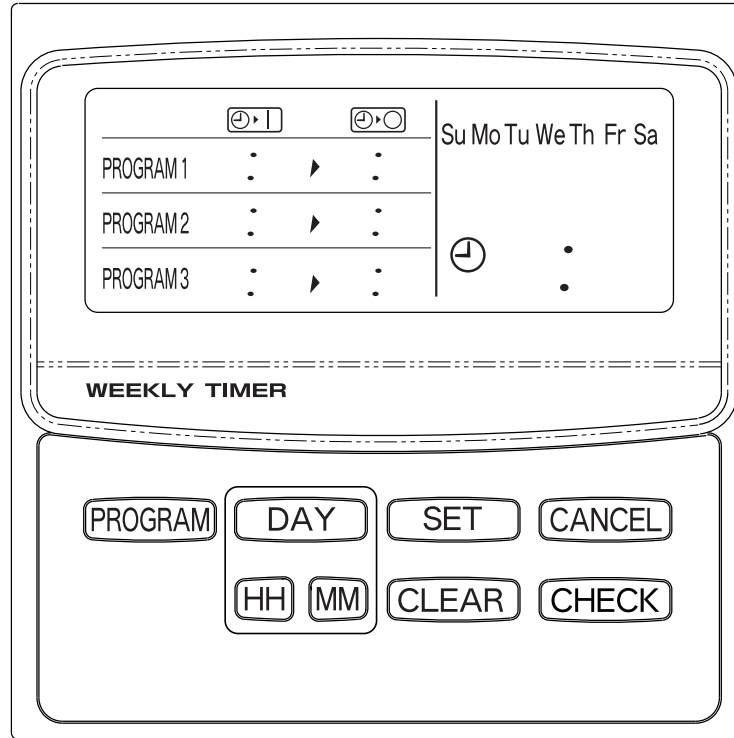

1. Power failure

When the power resumes after a power failure, the display shown on the above will appear (the colon of the present time indicator “:” will blink).

To restart operation

- ① Turn on the power (or the circuit breaker) for the air conditioner.
- ② Turn on the air conditioner with the remote controller.
- ③ Press the PROGRAM button of the programmable weekly timer.
The colon (:) stops blinking, the clock display will appear and the ordinary indicator mode will resume.
Your program is saved with the backup, therefore you do not need to program again.

2. The operation of the programmable weekly timer and air conditioners

The operation of air conditioners with the programmable weekly timer can be controlled with the timer or the remote controller.

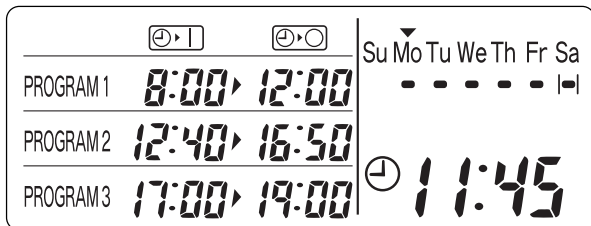

Ex. 1: Daily operation

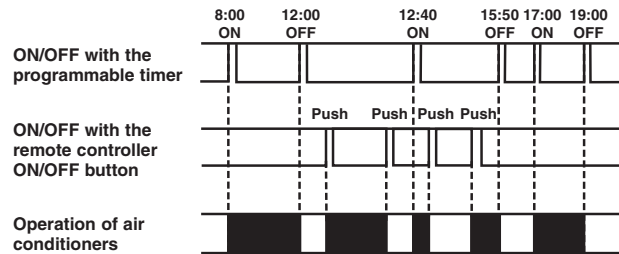

Ex. 2: Weekly operation

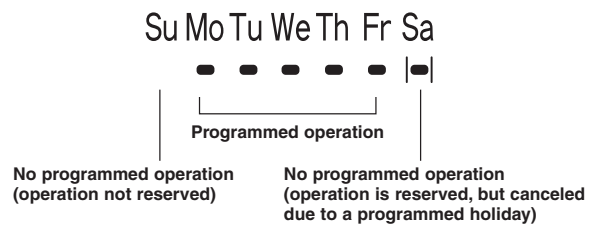

Save These Instructions!



SHA-KC64UG

System Controller for Split System Air
Conditioner

• *INSTRUCTION MANUAL*

Contents

	Page
Product Information	2
Alert Symbols	2
Installation Location	3
Electrical Requirements	3
Safety Instructions	3
How to Use the System Controller	4
■ Functions of buttons	4
■ Display	7
■ How to start group operation	8
■ How to start collective operation	9

Product Information

If you have problems or questions concerning your Air Conditioner, you will need the following information. Model and serial numbers are on the nameplate on the bottom of the cabinet.

Model No. _____ Serial No. _____

Date of purchase _____

Dealer's address _____

Phone number _____

Alert Symbols

The following symbols used in this manual, alert you to potentially dangerous conditions to users, service personnel or the appliance:



WARNING

This symbol refers to a hazard or unsafe practice which can result in severe personal injury or death.



CAUTION

This symbol refers to a hazard or unsafe practice which can result in personal injury or product or property damage.

Installation Location

- We recommend that this system controller be installed properly by qualified installation technicians in accordance with the Installation Instructions provided with the system controller.



WARNING

- Do not install this system controller where there are fumes or flammable gases, or in an extremely humid space such as a greenhouse.
- Do not install the system controller where excessively high heat-generating objects are placed.

Electrical Requirements

1. All wiring must conform to the local electrical codes. Consult your dealer or a qualified electrician for details.
2. Wiring must be done by a qualified electrician.



CAUTION

To warm up the system, the power mains must be turned on at least five (5) hours before operation. Leave the power mains ON unless you will not be using this appliance for an extended period.

Power mains

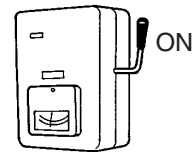

Safety Instructions

- Read this booklet carefully before using this system controller. If you still have any difficulties or problems, consult your dealer for help.
- The air conditioner is designed to give you comfortable room conditions. Use this only for its intended purpose as described in the Instruction Manual.



WARNING

- Never touch the unit with wet hands.
- Never use or store gasoline or other flammable vapor or liquid near the air conditioner — it is very dangerous.
- The air conditioner has no ventilator for intaking fresh air from outdoors. You must open doors or windows frequently when you use gas or oil heating appliances in the same room, which consume a lot of oxygen from the air. Otherwise there is a risk of suffocation in an extreme case.



CAUTION

- Do not turn the air conditioner on and off from the power mains switch. Use the ON/OFF operation button.
- Do not stick anything into the air outlet of the outdoor unit. This is dangerous because the fan is rotating at high speed.
- Do not let children play with the air conditioner.
- Do not cool or heat the room too much if babies or invalids are present.





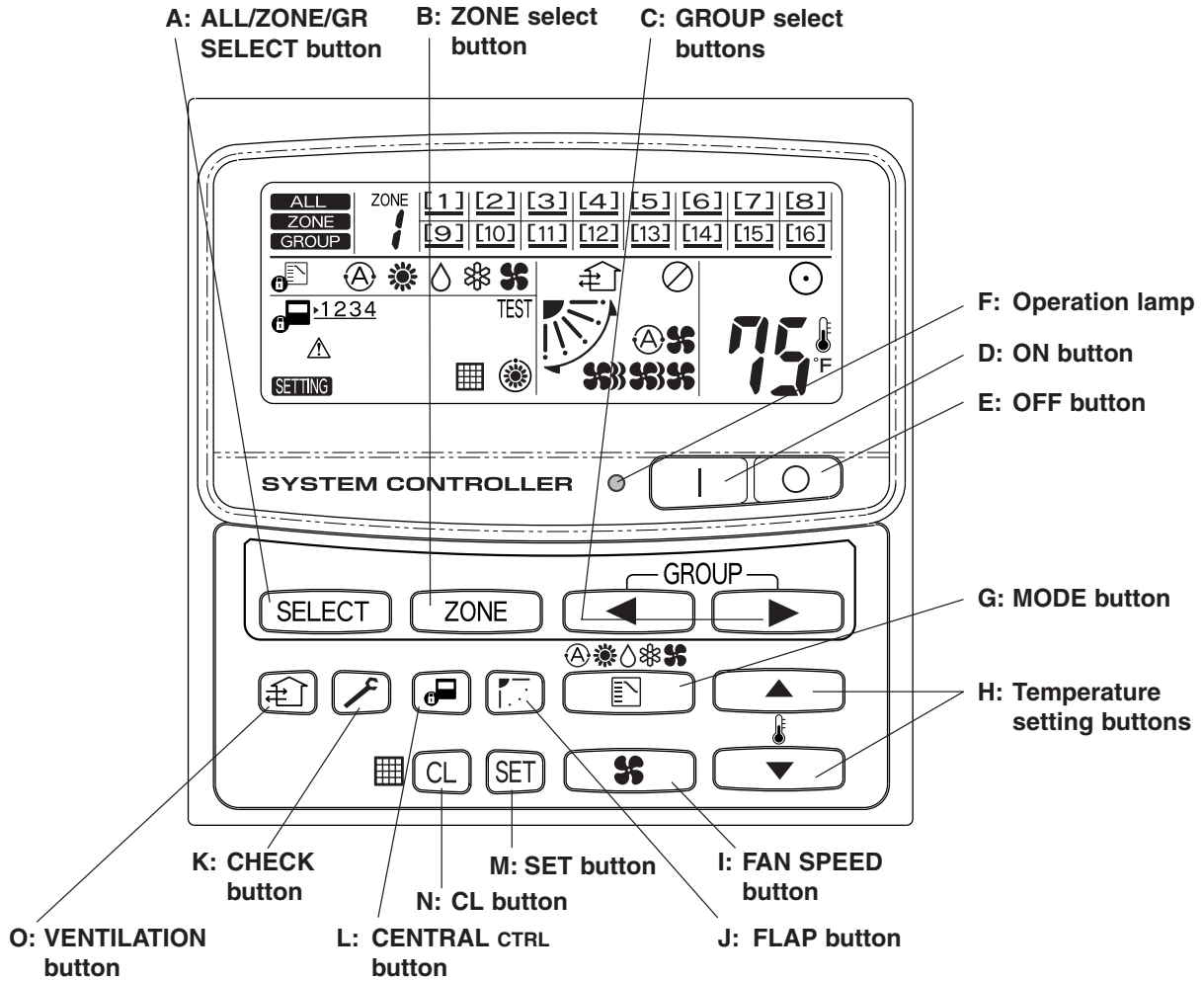





How to Use the System Controller

■ Functions of buttons



<p>A: ALL/ZONE/GR SELECT button SELECT</p> <div style="border: 1px solid black; padding: 5px; margin: 5px 0;"> <p style="text-align: center;">ALL</p> <table style="width: 100%; border-collapse: collapse;"> <tr> <td style="border: 1px solid black; padding: 5px; width: 50%;"> <p style="text-align: center;">ZONE1</p> <div style="border: 1px solid black; padding: 2px; margin: 2px;">GR1 UNIT UNIT</div> <div style="border: 1px solid black; padding: 2px; margin: 2px;">GR2 UNIT</div> <div style="border: 1px solid black; padding: 2px; margin: 2px;">GR3 UNIT</div> </td> <td style="border: 1px solid black; padding: 5px; width: 50%;"> <p style="text-align: center;">ZONE2</p> <div style="border: 1px solid black; padding: 2px; margin: 2px;">GR1 UNIT UNIT</div> <div style="border: 1px solid black; padding: 2px; margin: 2px;">GR2 UNIT</div> <div style="border: 1px solid black; padding: 2px; margin: 2px;">GR3 UNIT</div> </td> </tr> </table> </div> <p style="text-align: right;">NOTE</p>	<p style="text-align: center;">ZONE1</p> <div style="border: 1px solid black; padding: 2px; margin: 2px;">GR1 UNIT UNIT</div> <div style="border: 1px solid black; padding: 2px; margin: 2px;">GR2 UNIT</div> <div style="border: 1px solid black; padding: 2px; margin: 2px;">GR3 UNIT</div>	<p style="text-align: center;">ZONE2</p> <div style="border: 1px solid black; padding: 2px; margin: 2px;">GR1 UNIT UNIT</div> <div style="border: 1px solid black; padding: 2px; margin: 2px;">GR2 UNIT</div> <div style="border: 1px solid black; padding: 2px; margin: 2px;">GR3 UNIT</div>	<p>Use this button to select one of the following:</p> <p>ALL: Used for turning all the air conditioners on and off.</p> <p>ZONE: Used for turning all the air conditioners of each zone on and off.</p> <p>GR: Used for turning all the air conditioners of each group on and off.</p> <p>A maximum of four zones and 16 groups (units) in a zone can be set.</p>
<p style="text-align: center;">ZONE1</p> <div style="border: 1px solid black; padding: 2px; margin: 2px;">GR1 UNIT UNIT</div> <div style="border: 1px solid black; padding: 2px; margin: 2px;">GR2 UNIT</div> <div style="border: 1px solid black; padding: 2px; margin: 2px;">GR3 UNIT</div>	<p style="text-align: center;">ZONE2</p> <div style="border: 1px solid black; padding: 2px; margin: 2px;">GR1 UNIT UNIT</div> <div style="border: 1px solid black; padding: 2px; margin: 2px;">GR2 UNIT</div> <div style="border: 1px solid black; padding: 2px; margin: 2px;">GR3 UNIT</div>		
<p>B: ZONE select button ZONE</p>	<p>Use this button to select a zone (1 to 4) to operate individually.</p>		
<p>C: GROUP select buttons</p> <div style="text-align: center;"> ← → </div>	<p>Use these buttons to select a group (1 to 16) to operate individually.</p>		

■ Functions of buttons
(Continued)

<p>K: CHECK button </p>  <p>CAUTION</p>	<p>This button is used only when servicing the air conditioner. Do not use the CHECK button for normal operation.</p>
<p>L: CENTRAL CTRL button </p>	<p>Use this button to inhibit individual operation by remote controller as follows:</p> <p> 1234</p> <ol style="list-style-type: none"> 1: Individual ON/OFF operation is inhibited. 2: Individual ON/OFF, MODE and Temperature setting operation is inhibited. 3: Individual MODE and Temperature setting operation is inhibited. 4: Individual MODE operation is inhibited. <p>No indication: Central control is cleared. (Individual operation)</p>
<p>M: SET button </p> <p>NOTE</p>	<p>This button is used for setting indoor unit's address when installing the air conditioner. Do not use the SET button for normal operation.</p>
<p>N: CL button </p>	<p>Use this button to reset the filter sign .</p> <p>The air conditioner has the timer for the filter and informs you when the filter needs cleaning.</p>
<p>O: VENTILATION button </p>	<p>Use this button when you installed a fan available in the market. Pressing this button turns on and off the fan. When turning off the air conditioner, the fan will also turned off. While the fan is operating,  will appear in the display. If  is displayed when pressing the ventilation button, no fans are installed.</p>

■ Display

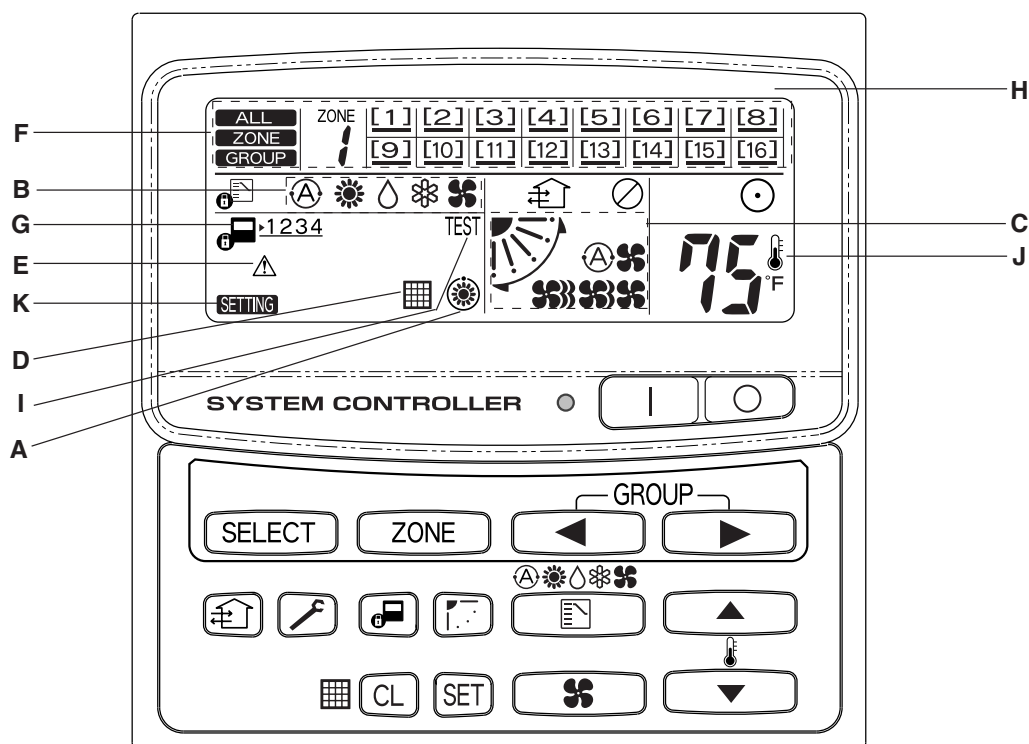

Description

- A:** When the unit is in the heating standby mode, the indicator appears.
- B:** The currently selected operation mode is displayed.
- C:** The currently selected FAN SPEED, Airflow Direction and SWEEP settings are displayed.
- D:** This indication appears when the filter needs cleaning.
- E:** This indication appears only when an abnormality occurs within a unit.
- F:** The currently selected mode (ALL, ZONE or GROUP), ZONE number and GROUP number are displayed.

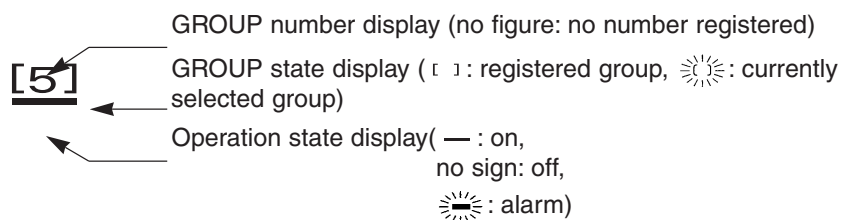

- G:** The currently selected central control mode (1, 2, 3 or 4) is displayed.
- H:** Lights when any of the air conditioners under the system control is operating; turns off when none of the air conditioners under the system control is operating. Blinks when any conditioner is operating under abnormal conditions and its protection functionality is working.
- I:** When the button is pressed for more than four seconds, the TEST indicator appears.
- J:** This indication appears when the temperature is set.
- K:** When turning on the power switch of the system controller, **SETTING** sign blinks for a few minutes. While blinking, any controls using the system controller are inhibited. This is because the system controller is verifying connected groups.

■ How to start group operation

To start group operation

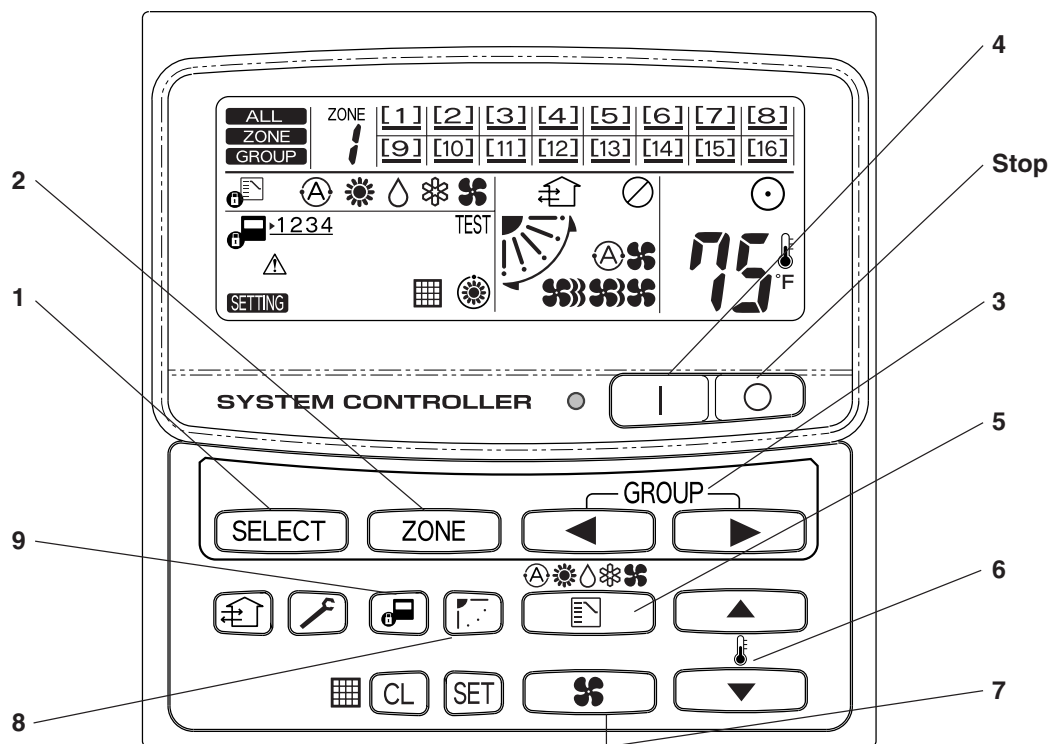

Power	Turn the power supply switch on more than 5 hours before starting operation.
1	Press the SELECT button and select GROUP.
2	Select the ZONE No. including the group to be operated by pressing ZONE button.
3	Select the GROUP No. to be operated by pressing GROUP select buttons ◀ ▶.
4	Press the ON button.
5	Set the operation mode by pressing the MODE button.
6	Set the desired temperature by pressing one of the temperature setting buttons ▲ ▼.
7	Set the desired fan speed by pressing the FAN SPEED button.
8	Set the airflow direction to a specific angle or sweep mode.
9	By pressing , select your desired setting. Individual: → Controls with the remote controller are possible. Central 1: → Individual ON/OFF operation with the remote controller is inhibited. Central 2: → Individual ON/OFF, MODE, and Temp. setting operations with the remote controller are inhibited. Central 3: → Individual MODE and Temp. setting operations with the remote controller are inhibited. Central 4: → Individual MODE operation with the remote controller is inhibited. • Under Central/Individual settings other than listed above, “CENTRAL” is displayed.
AUTO Operation	Depending on the difference between the temperature setting and the room temperature, heating and cooling alternate automatically so that a uniform room temperature is maintained.
Stop	Confirming the GROUP No. to be selected, press the OFF button.

NOTE The flap setting can be performed only for units that have no remote controllers.

■ How to start collective operation

To start collective operation (ALL or ZONE)

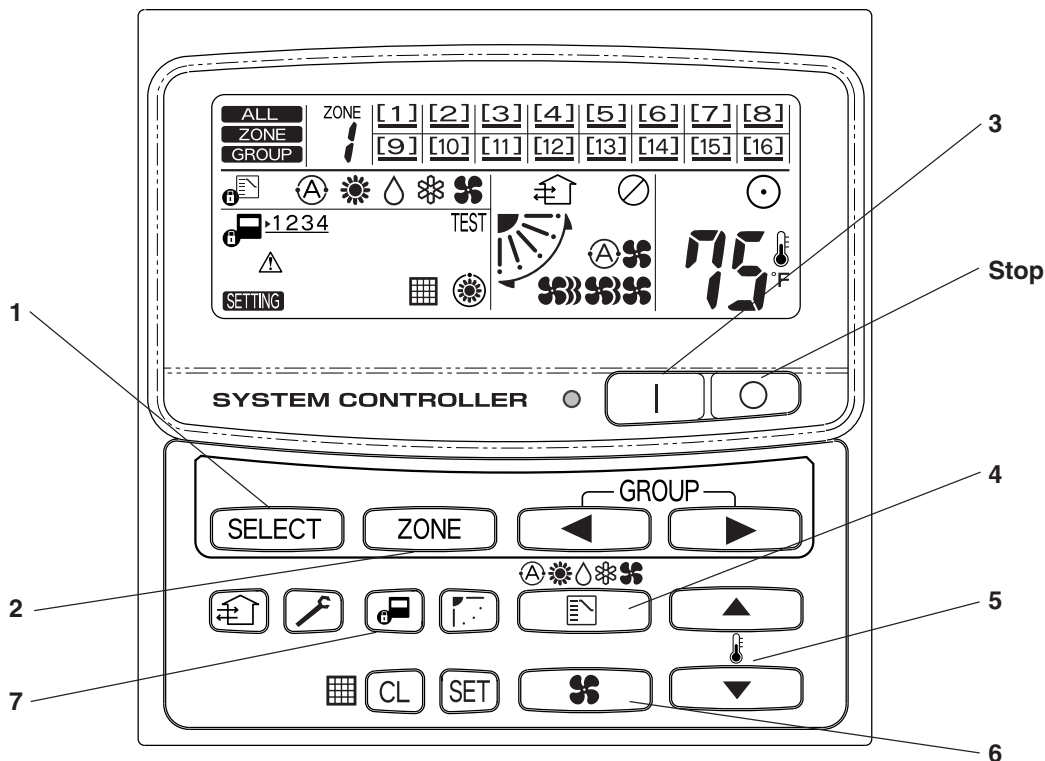

Power		Turn the power supply switch on 5 hours or more before starting operation.
1		Press the SELECT button and select ALL or ZONE. In case of ZONE collective operation.
2		Select the ZONE No. to be operated by pressing ZONE button.
3		Press the ON button.
4		Set the operation mode by pressing the MODE button.
5		Set the desired temperature by pressing one of the temperature setting buttons ▲ ▼.
6		Set the desired fan speed by pressing the FAN SPEED button.
7		Select the control mode.
Stop		Confirming the ZONE No. to be selected or ALL indication, press the OFF button.

NOTE In the ALL or ZONE mode, no flap setting can be performed. If necessary, you should select the GR mode and use the FLAP button

**SANYO FISHER COMPANY
A DIVISION OF SANYO NORTH AMERICA CORPORATION
21605 Plummer Street
Chatsworth, CA 91311 U.S.A.**

**In Canada
SANYO Canada Inc.
300 Applewood Crescent
Concord, Ontario,
L4K 5C7, Canada**